

NS-Series

CX-Designer

Ver. 3.□

USER'S MANUAL

OMRON

NOTE

All rights reserved. No part of this publication may be reproduced, stored in a retrieval system, or transmitted, in any form, or by any means, mechanical, electronic, photocopying, recording, or otherwise, without the prior written permission of OMRON.

No patent liability is assumed with respect to the use of the information contained herein. Moreover, because OMRON is constantly striving to improve its high-quality products, the information contained in this manual is subject to change without notice. Every precaution has been taken in the preparation of this manual.

Nevertheless, OMRON assumes no responsibility for errors or omissions. Neither is any liability assumed for damages resulting from the use of the information contained in this publication.

Trademarks

- Microsoft, and Windows are either registered trademarks or trademarks of Microsoft Corporation in the United States and other countries.
- ODVA, CIP, CompoNet, DeviceNet, and EtherNet/IP are trademarks of ODVA.

Other company names and product names in this document are the trademarks or registered trademarks of their respective companies.

Copyrights

Microsoft product screen shots reprinted with permission from Microsoft Corporation.

CX-Designer

Ver. 3.□

User's Manual

Revised April 2016

Notice:

OMRON products are manufactured for use according to proper procedures by a qualified operator and only for the purposes described in this manual.

The following conventions are used to indicate and classify precautions in this manual. Always heed the information provided with them. Failure to heed precautions can result in injury to people or damage to property.

 **DANGER** Indicates an imminently hazardous situation which, if not avoided, will result in death or serious injury. Additionally, there may be severe property damage.

 **WARNING** Indicates a potentially hazardous situation which, if not avoided, could result in death or serious injury. Additionally, there may be severe property damage.

 **Caution** Indicates a potentially hazardous situation which, if not avoided, may result in minor or moderate injury, or property damage.

OMRON Product References

All OMRON products are capitalized in this manual. The word “Unit” is also capitalized when it refers to an OMRON product, regardless of whether or not it appears in the proper name of the product.

The abbreviation “Ch,” which appears in some displays and on some OMRON products, often means “word” and is abbreviated “Wd” in documentation in this sense.

The abbreviation “PLC” means Programmable Controller. “PC” is used, however, in some Programming Device displays to mean Programmable Controller.

Visual Aids

The following headings appear in the left column of the manual to help you locate different types of information.

Note Indicates information of particular interest for efficient and convenient operation of the product.

1,2,3... 1. Indicates lists of one sort or another, such as procedures, checklists, etc.

Terminology

NS-series PT	A Programmable Terminal in the NS Series manufactured by OMRON.
PLC	A Programmable Logic Controller manufactured by OMRON.
Host	A PLC, factory computer, personal computer or other controller controlling an NS-series PT.
NS-Designer	The NS-NSDC1-V□ NS-Designer produced by OMRON. The NS-Designer is an applications software package that enables creating screen data for NS-series PTs.
CX-One	The CXONE-AL□□D-V4 CX-One FA Integrated Tool Package produced by OMRON. This applications software package provides all of the software packages for OMRON PLCs and components.
CX-Designer	The CX-Designer produced by OMRON.
NS-Runtime	The NS-Runtime software runs on Windows XP and provides the same functionality as an NS-series PT.

TABLE OF CONTENTS

SECTION 1

Overview	1
1-1 Features of the CX-Designer	2
1-2 Basic Operation Procedures	5

SECTION 2

Setting Up the CX-Designer	11
2-1 Preparations for Installation	12
2-2 Installing USB Drivers for NS-Series PTs	13

SECTION 3

Basic Operations of the CX-Designer	15
3-1 Starting and Exiting CX-Designer	16
3-2 Menu Commands	17
3-3 User Interface	24

SECTION 4

Useful Functions	35
4-1 Creating Screens Using Symbols	36
4-2 Using Screens from Other Projects	40
4-3 Classifying Screens by Application	42
4-4 Checking and Changing Functional Object Properties without Opening Property Setting Dialog Boxes	44
4-5 Listing and Editing Functional Object Properties	45
4-6 Editing Overlapping Objects	47
4-7 Creating Multi-language Labels	48
4-8 Checking Address Usage Status	49
4-9 Searching for Embedded Macros	50
4-10 Transferring Only Edited Data to PT	51
4-11 Creating Documents	52
4-12 How to Use Help	53
4-13 Integrated Simulation for the Entire System	54
4-14 Setting Security for Data Transfers with the PT	58
4-15 Setting Symbol Names and I/O Comments for Use as Labels	59
4-16 Executing Multiple Functions with a Single Operation	61
4-17 Replacing a Lamp with a Button	63
4-18 Creating Polygonal Lamps	65
4-19 Registering Contents	67
4-20 Using Machine Navigator	69
4-21 Enlarging Objects Proportional to Screen Size during Data Conversion	73
4-22 Batch-setting Label Formats	74

TABLE OF CONTENTS

Appendices

A	Comparison of Functions with NS-Designer	77
B	Shortcut Keys	81
C	Exchanging Data between NS-series Products	83

Revision History	89
-------------------------------	-----------

About this Manual:

The CX-Designer is a software package that enables creating screens for OMRON Programmable Terminals. Please be sure you understand the functions and performance of the CX-Designer to ensure correct application of the Programmable Terminals.

Please read this manual and related manuals carefully and be sure you understand the information provided before attempting to use the CX-Designer.

Section 1 provides an overview of the CX-Designer and its features and explains basic operating methods.

Section 2 describes how to install and uninstall the CX-Designer.

Section 3 describes the CX-Designer menus and basic procedures.

Section 4 describes convenient functions of the CX-Designer.

The **Appendices** provide a comparison between the CX-Designer and NS-Designer, tables of short-cut keys, and data transfer procedures between different versions of NS-series PT.

 **WARNING** Failure to read and understand the information provided in this manual may result in personal injury or death, damage to the product, or product failure. Please read each section in its entirety and be sure you understand the information provided in the section and related sections before attempting any of the procedures or operations given.

Guide to Version Upgrade

From CX-Designer Version 1.0 to Version 2.0

Item	Previous versions	New version
CX-Designer	Version 1.0 (NS-CXDC1-V1)	Version 2.0 (NS-CXDC1-V2)
NS system software	Version 6.2 or 6.5	Version 6.6
Integrated simulation	The only function available was simulated testing of PT screen operations on a personal computer.	Using a personal computer, a virtual PT can be connected to a virtual PLC (CX-Simulator) or to an actual PLC, and the operation of the entire PT-PLC system can be simulated. This makes it possible to reduce the total time involved in debugging.
Symbol programming without addresses	Symbol names, addresses, and comments were entered in symbol tables. Then the required symbols were selected from the symbol tables when creating screens.	Symbol names and comments can be input for symbol tables with no addresses. This allows screens to be created using symbol names without inputting addresses. Entering symbols in screen designs without addresses makes it possible to reduce the total time involved in design.
Multi-vendor connectivity	Not supported.	It is now possible to connect OMRON NS-series PTs to Mitsubishi FX-series PLCs, A-series PLCs, and Siemens S7-series PLCs.
Data security	The following two types of data transfers are possible between CX-Designer (running on a personal computer) and a PT: <ul style="list-style-type: none"> •Data transfers with the PT. •With data transfers using a Memory Card, data can be uploaded and downloaded by any user. 	A password can now be set for creating data. When data with a set password is transferred to a PT, the password is then required in order to upload the data. This prevents users who do not know the password from obtaining that data from the PT. In addition, a password can be required to transfer data to the PT. This prevents data from being accidentally overwritten.
User security	Any of five levels of passwords could be set for each functional object. A dialog box asking for the password was displayed each time an attempt was made to use a functional object for which a password had been set, and the object could not be used unless the password was input.	Once a user inputs the password to use a functional object for which a password has been set, the password does not have to be input again as long as the user continues using only functional objects for which lower level passwords have been set. Functional objects with a higher-level password cannot be manipulated. (A warning message will be displayed if an attempt is made.) This makes it possible to create applications that permit only the necessary operations by users who have entered passwords, and thus helps prevent faulty operations.
Consecutive line drawing	Not available.	Data in memory is treated as X and Y coordinates, and straight lines are drawn between the applicable coordinates to create consecutive line drawing. This makes it possible to handle applications involving the drawing of various graphics in two-dimensional space that could not be drawn using the existing graph components.

Item	Previous versions	New version
Improvements in broken-line graph	Number of monitor points: 256 max.	<ul style="list-style-type: none"> • Number of monitor points: 1,000 max. • Batch reading • Graph overwriting • Indirect specification of starting display position • Indirect specification of displaying/hiding graph lines • Indirect specification of displaying/hiding scale lines
Ladder Monitor	To use the Ladder Monitor it was necessary to copy the Ladder Monitor software from a CD-ROM to a Memory Card and to install the Memory Card in an NS-series PT. In addition, the PT was reset when starting or exiting the Ladder Monitor.	With version-2 NS-series PTs (except for the NS5-V2 and NSJ5), ladder monitoring is built into the PT as a standard feature, so no separate Memory Card is required. (A Memory Card is required for version-1 PTs, however, just as before.) In addition, neither version-1 nor version-2 PTs are reset when starting or ending the Ladder Monitor when Ladder Monitor version 2.8 is used. These improvements make the Ladder Monitor easier to use and reduce operating time.
Symbol table transfers when transferring screen data	Symbol tables set using the CX-Designer could be managed only by the CX-Designer, and symbol data was lost when data was uploaded from an NS-series PT.	When screen data is downloaded from the CX-Designer, the symbol tables are downloaded together with it. Likewise, when screen data is uploaded, the symbol tables are uploaded too.
Holding log and alarm information when transferring screen data	All of the log and alarm information in the PT was initialized when screen data was downloaded.	It is now possible to select whether log and alarm information is to be initialized when screen data is downloaded.
PLC data trace reading	Not supported. (This was a function of the CX-Programmer.)	Trace results from data traces (which is a CPU Unit function) can now be read by the PT and displayed in time chart format. (CSV files cannot be saved.) This makes it possible, using just the PT without CX-Programmer, to isolate the causes of errors that occur on-site.
Addition of European fonts	With the built-in raster fonts in NS-series PTs, Russian and Greek characters were full-width and not all characters were available.	All Russian and Greek characters are now available, and all characters are half-width.
Japanese file names	Two-byte characters could not be used for project file names.	Two-byte characters can now be used for project file names.
Video display mode setting	Image quality could not be adjusted when an NS-CA002 RGB/Video Input Unit was used.	It is now possible to select from three patterns for image quality adjustment. When a visual sensor is connected, even small display characters can be read. It is now also possible to adjust the display position for RGB display.
SAP (Smart Active Parts)	---	SAP has been added for the EJ1 Modular Temperature Controller, G3ZA Multi-channel Power Controller, and Troubleshooters.
Automatic using symbol names and I/O comments as labels and alarm messages	---	Symbol names and I/O comments of the communications addresses can be automatically used as functional object labels and alarm messages.
NS-Runtime	---	Projects can be created for NS-Runtime.
Temperature Controllers	Only the E5□N and E5□R Temperature Controllers can be set as hosts.	The EJ1 Modular Temperature Controller can now also be set as a host.

From CX-Designer Version 2.0 to Version 2.1

Item	Previous versions	New version
CX-Designer	Version 2.0	Version 2.1
NS system software	Version 6.6	Version 7.0
Multi-vendor connectivity	---	It is now possible to connect NS-series PTs to the following devices. <ul style="list-style-type: none"> • OMRON Trajexia Motion Controllers • Yaskawa MP-series Machine Controllers • Yaskawa F7-series Varispeed and VS Mini V7-series Machine Controllers • Mitsubishi Q-series PLCs
NT compatibility	---	System memory can now be allocated to PLC memory areas in the same way as for the NT Series, enabling PLC ladder programs to be easily transferred when migrating from the NT Series to the NS Series.
Holding previous system memory values	When an NS-series PT was started, the initial screen set in the System Setup was always opened.	It is now possible to display at the next startup the screen that was being displayed when the program was closed.
Multilingual system capability	The system supported two languages: English and Japanese.	In addition to English and Japanese, the system now also supports German, French, Italian, Spanish, and Chinese (both traditional and simplified).
Multifunction Objects	Macros were required in order to executed multiple processes for a single functional object.	Multifunction Objects have been added to functional objects. With Multifunction Object, multiple processes can be registered and can then be executed with the press of a button. Processes that previously required the creation of macros can now be executed by simply setting properties.
Machine Navigator function	Multiple objects, such as frames, labels, and bitmaps, were used to change displays such as on-screen characters and BMP files. Contents of displays were set individually, which was time-consuming and made maintenance troublesome.	A Machine Navigator function and a functional object contents display function have been added. Machine Navigator provides unified control of text and image files (i.e., "contents") to be displayed, and the new display function displays those contents. Contents requiring association can be managed in ID units, and the display can be easily changed by simply changing the ID specification.
Flicker function	The only flicker method for objects was display color inversion.	The following flicker methods have been added. <ul style="list-style-type: none"> • Display/hide (entire object or label) • Flicker color specification (fill color, character, and line colors)
Improved alarm/event summary and history display	When the history was displayed using the Alarm/event Summary & History command, the same alarm/event was displayed in multiple places for each date of occurrence. This made it difficult to check the frequency of occurrence. In addition, in some cases there were many items to be displayed and not all of them could fit on the screen.	A function has been added to provide a summary of a particular alarm/event on a single line, making it possible to quickly check conditions without unnecessary displays. A horizontal scrolling function has also been added to allow all items to be checked.
Fonts	Raster fonts could be set for objects with changing display character strings, such as numeric displays and inputs. Rounded areas became rough, however, when the font size was increased.	Scalable fonts have been added to enable smooth displays. Gothic numeral and 7-segment displays have also been added to allow more attractive and up-to-date screens to be created.

Item	Previous versions	New version
Improved screen switching function	---	Speed and bitmap performance have been improved for switching screens.
Improved connection operations	When serial ports A and B were both set for use for NT Links, "Connecting" was displayed if either of the hosts was not connected.	Even if one host is not connected, the monitoring results of the connected host can be displayed on the screen without "Connecting" being displayed.
SAP Library allocated unit number and communications setting information display	SAP Library settings could not be checked even by displaying addresses using screen data checking from the System Menu.	<p>The following information can now be displayed.</p> <ul style="list-style-type: none"> • Command destination port names • Destination network addresses • Destination node addresses • Destination unit numbers • DeviceNet Slave Unit address and Inverter node addresses
Bar codes	The maximum length of data that could be processed by an NS-series PT was 40 bytes.	The maximum data length has been increased to 254 bytes, allowing the data to be processed by two-dimensional bar code readers.
Test screens	---	<p>The following functions have been added to test screens.</p> <ul style="list-style-type: none"> • Zoom • Always displaying on top • Starting test screens in the previous display position and zoom status
DXF files	DXF files could not be accessed.	It is now possible to convert DXF files to graphics and position them with the CX-Designer.
Initialization options for alarm/event history data	When the alarm/event history data was cleared by using \$SB32, all history data was cleared including current alarms or events.	System Memory \$SW40 has been added so that it is now possible to specify initializing cleared or confirmed history data.
Changing host settings with the System Menu	The settings of a host connected by Ethernet or Controller Link could not be checked with the System Menu.	A list of hosts can now be displayed by selecting Communications Settings from the System Menu. It is now also possible to change the host network address, node address, and host type.

From CX-Designer Version 2.1 to Version 3.0

Item	Previous versions	New version
CX-Designer	Version 2.1	Version 3.0
NS system software	Version 7.0	Version 8.0
CJ2 compatible	---	Connections to CJ2-series PLCs are now supported.
EtherNet/IP compatible	---	Tag message communications are now supported.
Ladder Monitor	---	<p>Ladder Monitor functionality and operability have been greatly improved. The main functionality improvements are as follows.</p> <ul style="list-style-type: none"> • The Ladder Monitor can be started from the alarm/event summary and history. Communications addresses set as alarms or events can be searched for automatically. • The display color and size was updated. • I/O comments can be read from the PLC. • The number of rows of I/O comments displayed can be changed. • Search functionality, such as address searches and return searches, have been added, making searching much more powerful. • The number of points that can be registered for I/O monitoring was increased. • It is possible to search for or change the present value of the address the cursor is on. • The input format of the display of present values for words can be changed between hexadecimal, decimal, and signed decimal format. • The display can be captured and saved as a bitmap file.
Operation log	Previously, operations other than those on the PT, such as the switches on the front of the control board, could not be logged.	<p>The following functions have been added to the operation log.</p> <ul style="list-style-type: none"> • It is possible to log ON/OFF changes for a specified communications address. For example, by assigning a communications address to the switch on the front of the control panel, operations other than those on the PT display can also be logged. • Messages can be set in the operation log. • It is possible to save history files (csv files) and display the operation log screen from the System Menu using a Multifunction Object. • Multiple history files can be saved.
PLC data trace	Previous versions supported only bit data tracing.	<p>The following functions have been added to the PLC data trace.</p> <ul style="list-style-type: none"> • Data traces for words are now supported. • Data trace results can now be saved as CSV files. • The PLC data trace display can be captured and saved as a bitmap file. • The PLC symbol table can be read, and the I/O comments for the communications addresses being traced can be displayed.

Item	Previous versions	New version
Screen transfers	Previously, when uploading project data from the PT, the user display on the PT would change to the transfer screen. Also, after transfer finished, it was necessary to reset the PT.	When uploading project data, it is no longer necessary to change to the transfer screen while uploading, nor is it necessary to reset the PT when the transfer has finished. Now, the user can continue operating the PT screens even while uploading.
Multivendor support	---	The PT can now be connected to the following devices. <ul style="list-style-type: none"> • Rockwell Automation (Allen-Bradley) SLC500 Controller, MicroLogix, PLC-5, CompactLogix, and ControlLogix • Modbus RTU-compatible devices
Screen saver	---	The time until the screen saver starts can be indirectly specified.
String table support for alarms and events	---	Alarm and event message text strings can now be viewed from string tables.
Disable function for screen inputs	---	It is now possible to enabled or disable inputs and outputs to the entire screen when a specified communications address is turned ON or OFF.

From CX-Designer Version 3.0 to Version 3.007

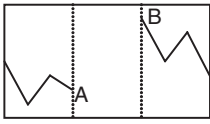
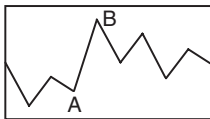
Item	Previous versions	New version
CX-Designer	Version 3.0	Version 3.007
NS system software	Version 8.0	Version 8.1
Printer	---	PictBridge-compatible printers are now supported (except they are not supported by the NS5-□□0□, NSJ5-□□0□, and NSH5).
Multivendor support	---	The following PLCs can now be connected to an NS-series PT. <ul style="list-style-type: none"> • Yokogawa Electric FA-M3-series and FA-M3R-series PLCs.
Ladder Monitor	---	<ul style="list-style-type: none"> • CJ2-series PLCs are now supported. • The host connected to an NS-series PT over an EtherNet/IP network can now be monitored. <p>It is now possible to display a dialog box asking for a password if data will be modified, such as when changing present values.</p>
Data log graphs	<p>A line appeared on the data log graph while data was being logged and then blank spaces occurred at times when no data was logged.</p>  <p>Logging was stopped.</p> <p>No data logged.</p>	<p>A setting has been added to provide an option to compress the times when data was not logged so those times will not be displayed. This way only logged data will be displayed as one continuous line.</p>  <p>Periods when logging was stopped are displayed on a reduced time scale.</p> <p>Display showing compressed time when no data was logged.</p>

Item	Previous versions	New version
Initialization of alarm/event history data	When the alarm/event history data was cleared by using \$SB32 or \$SW40, the number of times alarm/events occurred was held in memory even though the other data was cleared.	A setting has been added to provide an option to clear the number of times alarm/events occurred along with the other alarm/event history data that was cleared.
Number of objects per screen	The maximum number of objects, including graphs and functional objects (i.e., frames and tables), was 1,024 per screen.	The number of objects per screen has been increased to a maximum of 1,024 functional objects (i.e., frames and tables) and up to 2,048 graphs.
Improved screen switching performance	---	The speed for switching screens when the drawing method is set to <i>Display frames and fixed objects first</i> has now been improved. (This capability requires project version 8.1 or higher.)
Project data conversion	When project data was converted, the position and size of the screen objects were left unchanged by the conversion. Also NS-Runtime projects could not be converted to NS projects.	It is now possible to change the position and size of all objects proportional to the size of the screen, such as when converting data for a low-resolution PT to data for a high-resolution PT. In addition, NS-Runtime projects can now be converted to NS projects.
Importing labels from CSV files	When label text strings were imported from a CSV file, the original font that was set for an object was subsequently applied to the object after importing the file.	Now the font for groups of labels can be changed all at once when label text strings are imported from a CSV file.
Changing initial values of functional objects	---	The initial values of the following functional objects can be changed to make them easier to use. <ul style="list-style-type: none"> • Numeral Display & Input • String Display & Input • Alarm/Event Summary & History • Frame

From CX-Designer Version 3.007 to Version 3.008

Item	Previous versions	New version
CX-Designer	Version 3.007	Version 3.008
NS system software	Version 8.1	Version 8.1
NS15 compatibility	---	Connection to an NS15 PT is now supported.

From CX-Designer Version 3.008 to Version 3.1

Item	Previous versions	New version
CX-Designer	Version 3.008	Version 3.1
NS-series PT software version	Version 8.1	Version 8.2
Device data transfer	---	Conditions can be set to transfer data from a source to a destination.
SPMA transfers	---	Screen data transfers can be performed through USB to access other devices. For details, refer to <i>CX-Designer Online Help</i> .
Batch format settings	---	The format for all labels can be set at the same time.
Batch label settings	---	A specified character string can be set for all of the labels for objects at the same time.

Item	Previous versions	New version
String Display and Input objects	---	An input method setting was added to move the input focus to in front of the character string when the focus is set.
Analogue Meter improvements	---	The shape of the needle can be set to a straight line, arrow, or triangle arrow. The line width can be changed to up to 3 dots.
Password input keyboards	---	The user can specify the keyboards to use to input passwords.
Macros added	---	Trigonometric and floating-point functions were added.
Screen switch settings	---	The default setting for the display sequence for screens now gives priority to displaying fixed objects and frames first.
Improvements in creation methods for fixed objects	---	The method to create sectors and arcs has been improved.
Data log graphs for 128 points	The previous maximum was 50 points.	The total number of addresses for constant logging was increased to 128 points max.
Data blocks with 512 KB	The previous size was 100 KB.	The size of one data block was increased to 512 KB.
CP1W-CIF41 compatibility	---	Communications are now possible through the CP1W-CIF41.

From CX-Designer Version 3.1 to Version 3.113

CX-Designer	Version 3.1	Version 3.113
NS system software	Version 8.2	Version 8.3
Importing and exporting CSV files	---	Labels can now be imported and exported in batches.
Contents displays	---	Contents can now be imported and exported.
Alarm/Event Summary & History	---	Display compatibility with the NS-series PT has been improved for Alarm/Event Summary & History objects.

From CX-Designer Version 3.113 to Version 3.2

CX-Designer	Version 3.113	Version 3.2
NS system software	Version 8.2	Version 8.3
Numeral Display & Input	Inputting data was always possible from both a barcode reader and functional object.	The input method is specified to enable inputting data from a barcode reader or functional object, but not both.
String Display & Input	Inputting data was always possible from both a barcode reader and functional object.	The input method is specified to enable inputting data from a barcode reader or functional object, but not both.

CX-Designer	Version 3.113	Version 3.2
NS system software	Version 8.3	Version 8.4
Support for CJ2 data structures	---	CJ2 data structures are now supported.
PictBridge support improved	The printing orientation was fixed.	The printing orientation can be set.
Modbus support improved	---	Data can now be read for bit devices.

From CX-Designer Version 3.2 to Version 3.3

CX-Designer	Version 3.2	Version 3.3
NS system software	Version 8.4	Version 8.5
NJ-series Controller support	---	Connection to NJ-series CPU Units is now supported.

From CX-Designer Version 3.3 to Version 3.4

CX-Designer	Version 3.3	Version 3.4
NS system software	Version 8.5	Version 8.6
Support for NJ3 CPU Units	---	Connection to NJ3 CPU Units is now supported.
Improved multivendor support	---	An option setting was added to improve communications performance for Mitsubishi Q-series Controllers.

From CX-Designer Version 3.4 to Version 3.41

CX-Designer	Version 3.4	Version 3.41
NS system software	Version 8.6	Version 8.61
Integrated simulation with the Sysmac Studio	---	Integrated simulation with the Sysmac Studio is now supported.
Exclusive control of barcodes	---	It is now possible to set whether to disable inputting data from barcodes while the input pad is being used.

From CX-Designer Version 3.41 to Version 3.5

CX-Designer	Version 3.41	Version 3.5
NS system software	Version 8.61	Version 8.61
Palette function	---	The user-friendliness of the library is improved to support the function to be referred as Palette.
Support the change of the number of elements in array.	---	Supported the change of the number of elements in array.
Multittransfer	---	The destination should be specified previously to support the function to transfer the project.
Transfer setting is remained in the unit of project.	The transfer setting has been remained for each CX-Designer.	Supported the transfer setting is stored to the project.
Change simultaneously multiple screen/sheet properties	The property can be changed only with a single screen or sheet.	Supported the function to simultaneously change properties selecting multiple screens or sheets.

From CX-Designer Version 3.5 to Version 3.53

CX-Designer	Version 3.5	Version 3.53
NS system software	Version 8.61	Version 8.61
Mode selection at upload	Upload is always executed in the background in system version 8.0.	Enables to upload data using the transfer mode.
Support change in the number of string elements.	---	Supported change in the number of elements in string.

From CX-Designer Version 3.53 to Version 3.54

CX-Designer	Version 3.53	Version 3.54
NS system software	Version 8.61	Version 8.61
Mode selection at upload (Multittransfer)	Mode selection at upload did not support Multittransfer.	Enables Multittransfer for this mode selection.

From CX-Designer Version 3.54 to Version 3.55

CX-Designer	Version 3.54	Version 3.55
NS system software	Version 8.61	Version 8.61
Support displaying progression at removing variables.	The progression of the processing was not grasped when a variable is removed from a variable table.	Enables to display the progression of processing when a variable is removed.

CX-Designer	Version 3.54	Version 3.55
Support for newly creating variable in data types, string and array.	---	Enables to newly create a variable in data types, string and array.
Holding the layout of Edit Properties window.	The layout of Edit Properties window was returned to default setting after closing the window.	Even the Edit Properties window is closed, enables to hold the layout still.
Alert system version at transferring the data.	---	When the system version of the NS Unit is other than the set version, enables to alert a user the system version.
Enhancing the multitransfer.	---	<ul style="list-style-type: none"> • Supported the mode to neglect an alert to continue the transfer. • Supported the function to display the result of transfer on screen. • Enables to make transfer setting on screen.

From CX-Designer Version 3.55 to Version 3.56

CX-Designer	Version 3.55	Version 3.56
NS system software	Version 8.61	Version 8.61
Support Replacement function with tag.	The Replacement function did not support tag (only address).	Enables the Replacement function to support tag.
Support Repeat function with offset addresses in array of structures.	Repeat function did not support offset addresses in array of structures.	Enables Repeat function with offset addresses also in array of structures.

From CX-Designer Version 3.56 to Version 3.57

CX-Designer	Version 3.56	Version 3.57
NS system software	Version 8.61	Version 8.61
Support copying and pasting the objects available from Edit Properties	All selected data in the cells of Edit Properties could not be copied and pasted.	Enables all selected data in the cells of Edit Properties to be copied and pasted.

From CX-Designer Version 3.57 to Version 3.58

CX-Designer	Version 3.57	Version 3.58
NS system software	Version 8.61	Version 8.7
Improving specification of GETNUMVAL.	GETNUMVAL only operated after a numeral value is entered.	Enables GETNUMVAL to operate before entering numeral value.

From CX-Designer Version 3.58 to Version 3.62

CX-Designer	Version 3.58	Version 3.62
NS system software	Version 8.7	Version 8.8
Enhancing specification of Max. and Min. values.	Max. and Min. values for Numeral display & Input could be specified only with Immediate value or Indirect Specification.	Supports the difference from a current value as another way to specify the Max. and Min. values for Numeral display & Input.
Indirect Reference of Password	---	Enabled to indirectly specify a password for the designated level.

From CX-Designer Version 3.62 to Version 3.64

CX-Designer	Version 3.62	Version 3.64
NS system software	Version 8.8	Version 8.9
Support for NJ1 Series and NX7 Series	---	Supported connection with the NJ1 Series and NX7 Series.

Related Manuals:

The manuals related to using the CX-Designer are listed below. Manual suffixes have been omitted. Please be sure you have the most recent version for your area.

Installing the CX-Designer

CX-Designer User's Manual - - - - -V099

This manual describes how to install the CX-Designer and the user interface. It also describes characteristic functions and application methods.

Confirming Functional/Fixed Object Setting Procedures when Using the CX-Designer

CX-Designer Help

The online help feature explains CX-Designer operating methods and settings (including detailed settings for functional and fixed objects).

It also explains how to transfer screen data to the NS-series PT.

Using NS-series PT Functions and Troubleshooting Errors

NS-Series PT Programming Manual - - - - -V073

This manual describes using NS-series PT functions and application methods. It also provides troubleshooting methods in the event that problems occur with the PT.

Checking NS-series PT Functions, Operations, and Restrictions

NS-V1/V2-series PT Setup Manual - - - - -V083

This manual describes installation and connection procedures, general specifications, and other hardware information for NS-V1/V2-series PTs (NS15-V2, NS12-V1/V2, NS10-V1/V2, NS8-V1/V2, and NS5-V1/V2).

NS-series PT Setup Manual - - - - -V072

This manual describes installation and connection procedures, general specifications, and other hardware information for NS-series PTs (NS12, NS10, and NS7).

Installing the CX-Designer from the CX-One

CXONE-AL□□D-V4 CX-One Ver. 4.0 Setup Manual
- - - - -W463

This manual provides an overview of the CX-One FA Integrated Tool Package and describes installation methods.

Using an NS-series PT for the First Time

CX-Designer Introduction Guide - - - - -V089

This tutorial describes using a NS-series PT for first-time users, from simple screen creation to system operation.

Using NS-series PT Macros

Macro Reference

The online help for the CX-Designer provides detailed descriptions of the NS-series PT macro function. The same level of detail is also provided in this reference manual, which is installed

on the hard disk as a PDF file when the CX-Designer is installed. Use either the online help or this reference as required.

Checking PLC Functions and Operation

Operation Manuals for the PLC Being Used

For information on PLC operation and functions, refer to the operation manuals for the CPU Unit, Special I/O Units, CPU Bus Units, Communications Units, or other Units that you are using.

Checking NS-Runtime Functions, Operations, and Restrictions

NS-Runtime User's Manual - - - - -V093

This manual describes the special functions of NS-Runtime.

Terms and Conditions Agreement

● WARRANTY

- The warranty period for the Software is one year from the date of purchase, unless otherwise specifically agreed.
- If the User discovers defect of the Software (substantial non-conformity with the manual), and return it to OMRON within the above warranty period, OMRON will replace the Software without charge by offering media or download from OMRON's website. And if the User discovers defect of media which is attributable to OMRON and return it to OMRON within the above warranty period, OMRON will replace defective media without charge. If OMRON is unable to replace defective media or correct the Software, the liability of OMRON and the User's remedy shall be limited to the refund of the license fee paid to OMRON for the Software.

● LIMITATION OF LIABILITY

- THE ABOVE WARRANTY SHALL CONSTITUTE THE USER'S SOLE AND EXCLUSIVE REMEDIES AGAINST OMRON AND THERE ARE NO OTHER WARRANTIES, EXPRESSED OR IMPLIED, INCLUDING BUT NOT LIMITED TO, WARRANTY OF MERCHANTABILITY OR FITNESS FOR PARTICULAR PURPOSE. IN NO EVENT, OMRON WILL BE LIABLE FOR ANY LOST PROFITS OR OTHER INDIRECT, INCIDENTAL, SPECIAL OR CONSEQUENTIAL DAMAGES ARISING OUT OF USE OF THE SOFTWARE.
- OMRON SHALL HAVE NO LIABILITY FOR DEFECT OF THE SOFTWARE BASED ON MODIFICATION OR ALTERNATION TO THE SOFTWARE BY THE USER OR ANY THIRD PARTY.
- OMRON SHALL HAVE NO LIABILITY FOR SOFTWARE DEVELOPED BY THE USER OR ANY THIRD PARTY BASED ON THE SOFTWARE OR ANY CONSEQUENCE THEREOF.

● APPLICABLE CONDITIONS

USER SHALL NOT USE THE SOFTWARE FOR THE PURPOSE THAT IS NOT PROVIDED IN THE ATTACHED USER MANUAL.

● CHANGE IN SPECIFICATION

The software specifications and accessories may be changed at any time based on improvements and other reasons.

● ERRORS AND OMISSIONS

The information in this manual has been carefully checked and is believed to be accurate; however, no responsibility is assumed for clerical, typographical, or proofreading errors, or omissions.

SECTION 1

Overview

This section describes the features of the CX-Designer and the startup procedures for NS-series PTs for first-time users.

1-1	Features of the CX-Designer	2
1-1-1	Features	2
1-2	Basic Operation Procedures	5

1-1 Features of the CX-Designer

The CX-Designer is software that can be run on Windows to create screen data for NS-series Programmable Terminals (PTs).

The CX-Designer has a variety of functions to enable efficient screen creation and debugging.

Project Workspace
The entire project structure can be displayed in a directory tree.

Property List
Functional object property settings can be changed and checked without having to open a properties dialog box.

Output Window
Displays data such as search results and error details.

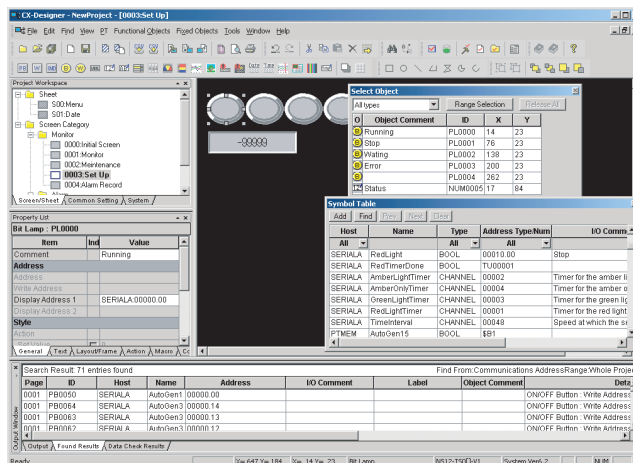

Edit Screens
Screen data displayed on the PTs can be created for a group of objects.

1-1-1 Features

Screens Can Be Created Using Symbols

Symbols can be used with the CX-Designer. Symbols are addresses to which names have been assigned. In addition to the existing method of directly inputting addresses to be browsed by functional objects, the addresses can also be set by using symbols (names). When the address allocated for a symbol is changed, the address is changed for all objects that access that symbol. This makes it easy to change address allocations and reuse screens. Symbols/variables can also be shared between the CX-Designer and CX-Programmer/Sysmac Studio by copying the symbols/variables from CX-Programmer symbol tables or Sysmac Studio variable tables to the CX-Designer.

Refer to 4-1 *Creating Screens Using Symbols* for details.

Project Management Using Project Workspace

Screens, alarms, and other common settings can be displayed in a directory tree in the CX-Designer project workspace. Projects are easy to manage because the entire project structure can be checked at a glance.

Screens and settings can be copied between multiple CX-Designer project workspaces. Screens can also be copied within the same project workspace. Refer to 4-2 *Using Screens from Other Projects* for details.

Easy Reuse of Screens

Screens and settings can be copied between multiple CX-Designer project workspaces. Screens can also be copied within the same project workspace. The common settings accessed by screens are also copied automatically.

If symbols are used, it also becomes easy to change addresses after screens have been copied. Refer to 4-2 *Using Screens from Other Projects* for details.

Screen Classification by Application for Easy Management

Screens can be classified into any category, e.g., by application, and displayed in a directory tree. When screens are created, consecutive screen numbers are automatically applied to screens in the same category. These numbers can also be changed. This makes screen management even easier.

Refer to 4-3 *Classifying Screens by Application* for details.

Functional Object Property Settings Using Property Lists	<p>Functional object settings can be changed and checked without having to open a dialog box.</p> <p>When more than one object is selected, common settings for those objects can be changed in one operation from the property list.</p> <p>Refer to <i>4-4 Checking and Changing Functional Object Properties without Opening Property Setting Dialog Boxes</i>.</p>
Edit Properties from Lists	<p>Properties of objects on the screen can be displayed in table format and the settings changed.</p> <p>Settings for more than one object can be changed at the same time and consecutive addresses can be automatically set.</p> <p>Refer to <i>4-5 Listing and Editing Functional Object Properties</i> for details.</p>
Select and Display Specified Objects	<p>Objects on the screen can be listed and specified objects selected. The screen display can also be limited to specified objects.</p> <p>This makes it easy to check and change the property settings for overlapping objects.</p> <p>Refer to <i>4-6 Editing Overlapping Objects</i> for details.</p>
Find Macros	<p>Embedded macros can be listed.</p> <p>This improves debugging efficiency by no longer requiring individual object property settings to be opened to find objects that use macros.</p> <p>Refer to <i>4-9 Searching for Embedded Macros</i> for details.</p>
Automatic Transfer of Edited Data Only	<p>Once screens have been transferred to the PT, quick transfers of only the changed data can be made automatically. Screens are edited and data transferred many times during debugging, so the quick transfer function greatly reduces transfer time and increases efficiency.</p> <p>Refer to <i>4-10 Transferring Only Edited Data to PT</i> for details.</p>
Easy Document Creation	<p>Common settings and property settings for objects in screens can be output in rich text format (.rtf). The output settings are displayed in a list for easier viewing.</p> <p>Screen images can also be output to bmp and jpg files.</p> <p>Refer to <i>4-11 Creating Documents</i> for details.</p>
Integrated Simulation for Entire PT-PLC System	<p>The test function of the CX-Designer can be connected to the CX-Simulator (a virtual PLC) or the simulation function of the Sysmac Studio. When the test function is combined with the simulation function of the Sysmac Studio, the user program for an NJ/NX-series Controller can be debugged. When the CX-Simulator is started, the PLC user program created using the CX-Programmer can be debugged on a personal computer together with screen data.</p>

In addition, the test function can be connected directly to an actual PLC. This enables debugging (including monitoring and settings) using actual I/O, Special I/O Units, and CPU Bus Units connected to the PLCs, as well as data from external devices and PLC data on the network.

1. Integrated operations with screens and user programs can be tested on a personal computer
2. Screen operations can be tested while connected to the actual PLC System (including external devices).

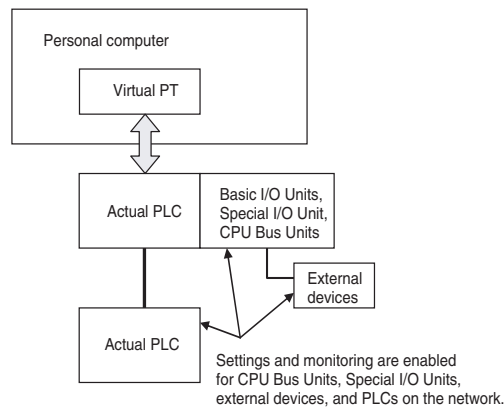
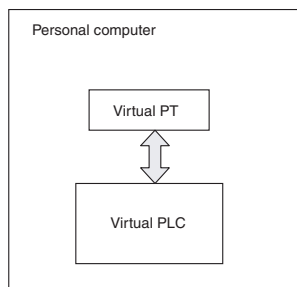

Prevent Unauthorized Uploading of Data from the PT (CX-Designer Version 2.0 and Higher)

To prevent data theft from the PT, a password can be required to upload project data. Data cannot be uploaded from the PT unless the correct password is input. A password can also be required for downloading data to prevent data from being accidentally overwritten.

Note Project data created using the NS-Designer can be used with the CX-Designer. Project data created using the CX-Designer can also be used with the NS-Designer. (Only project data versions supported by NS-Designer, however, can be used.)

1-2 Basic Operation Procedures

This section describes the basic procedures for creating screens using CX-Designer, transferring data to the PT, and displaying screens. Refer to the CX-Designer online help and the *NS Series Setup Manual* and *NS Series Programming Manual* for details.

Creating Projects and Screens on the CX-Designer

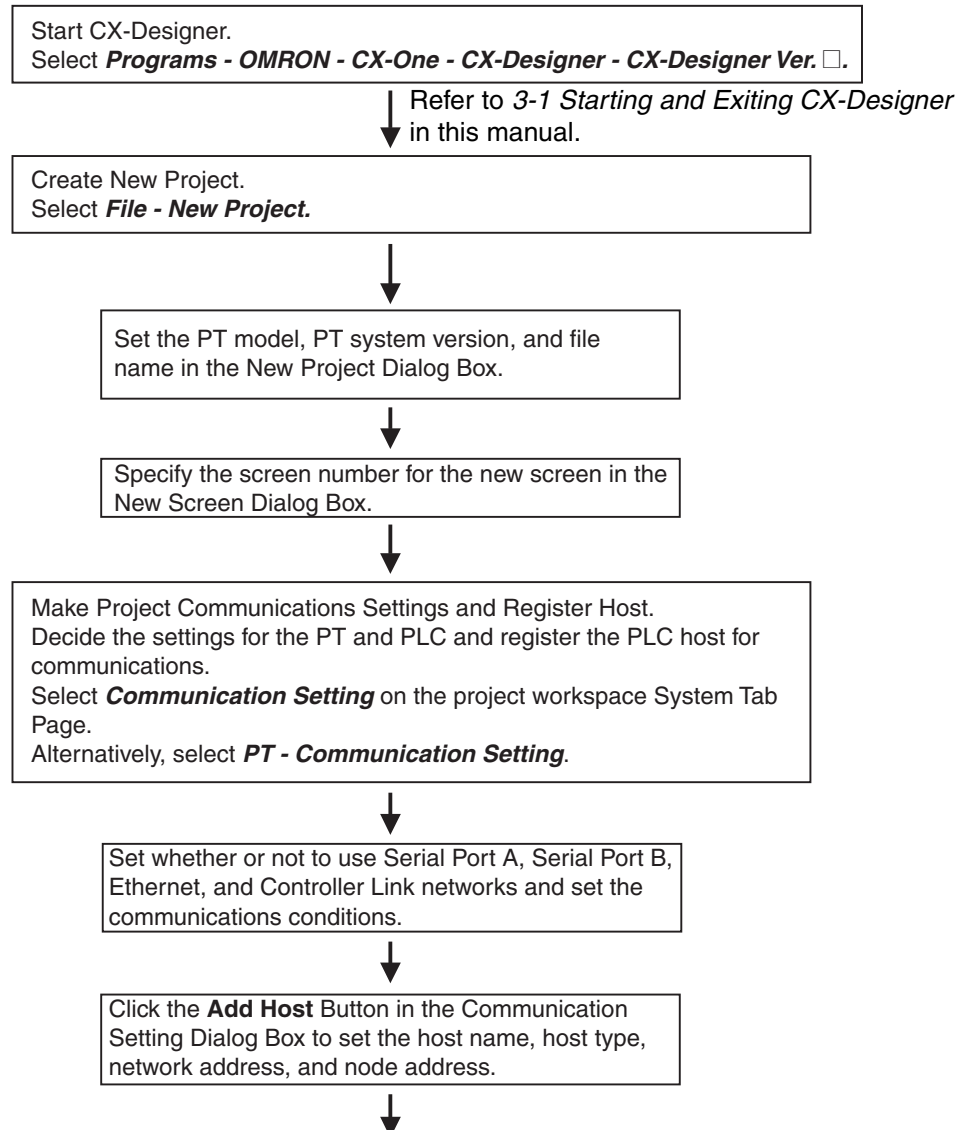

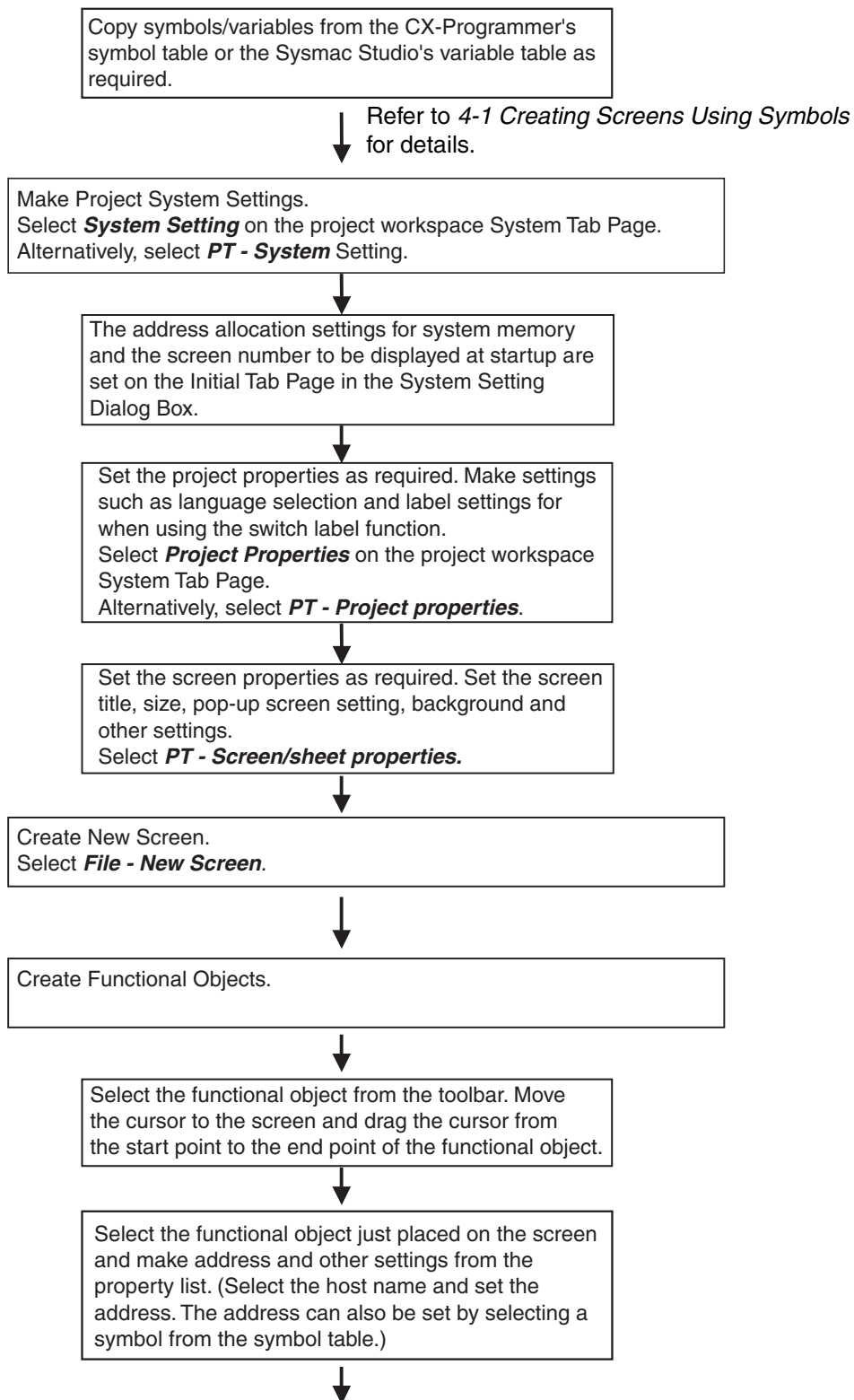

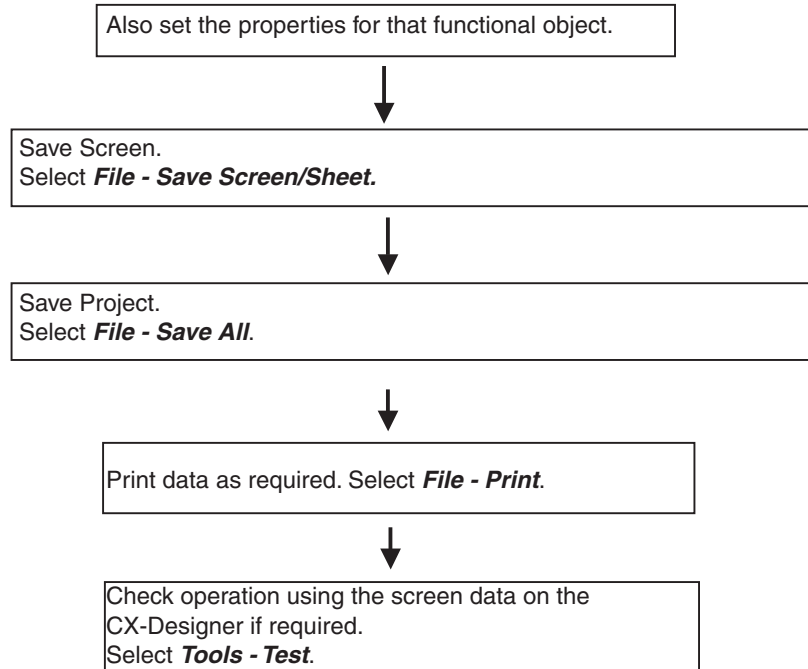

Debugging Newly Created Screen Data while Integrated with a Virtual or Actual PLC

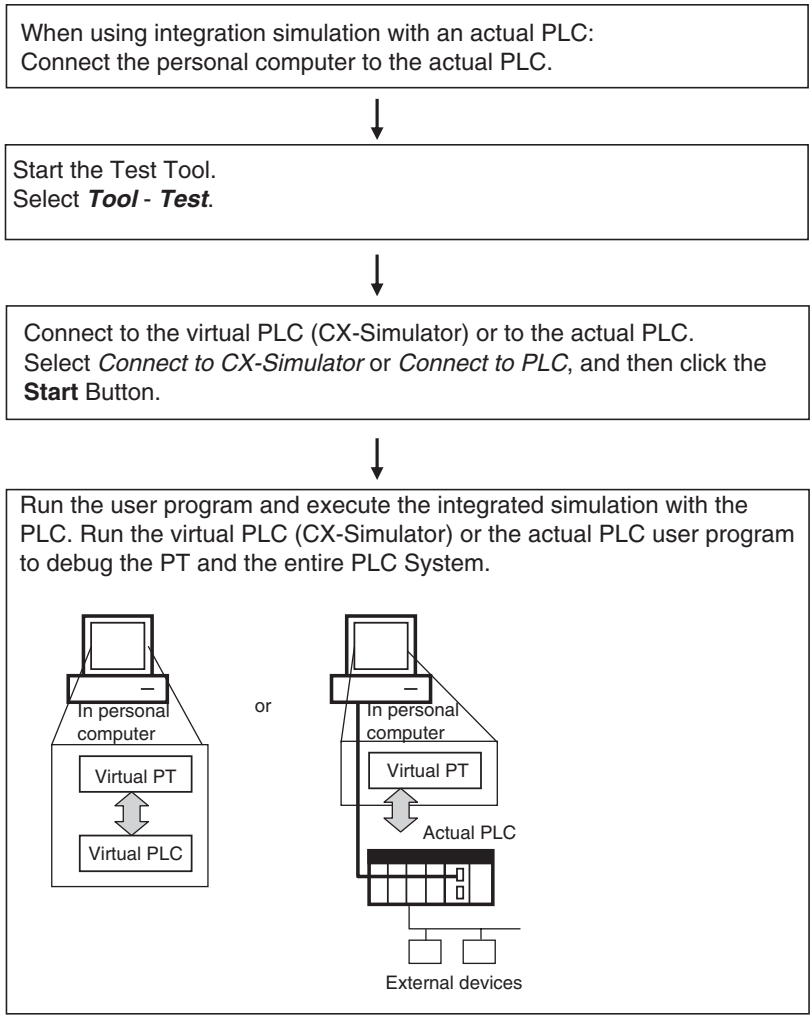

Note Integrated simulation with the simulation function of the Sysmac Studio must be started from the Sysmac Studio. For details, refer to the *Sysmac Studio Version 1 Operation Manual* (Cat. No. W504).

Transferring Projects and Screens to the PT

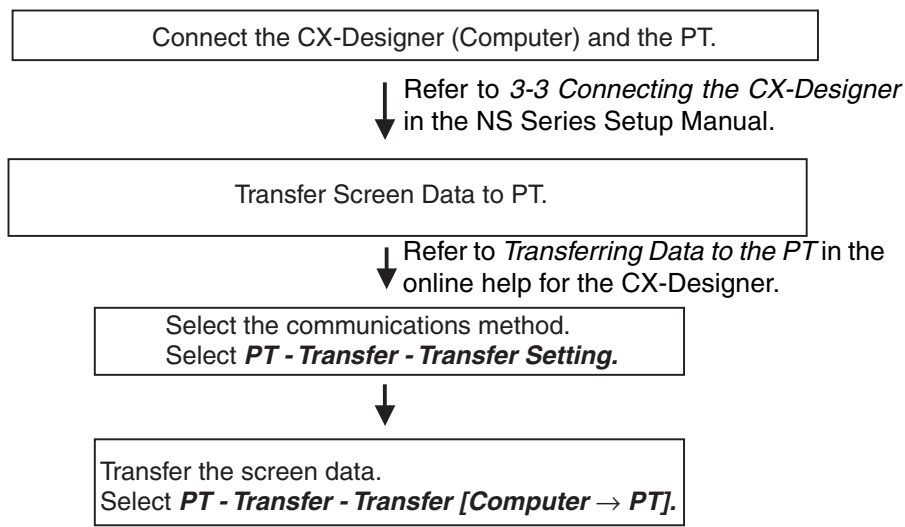

Communications between the PT and PLC

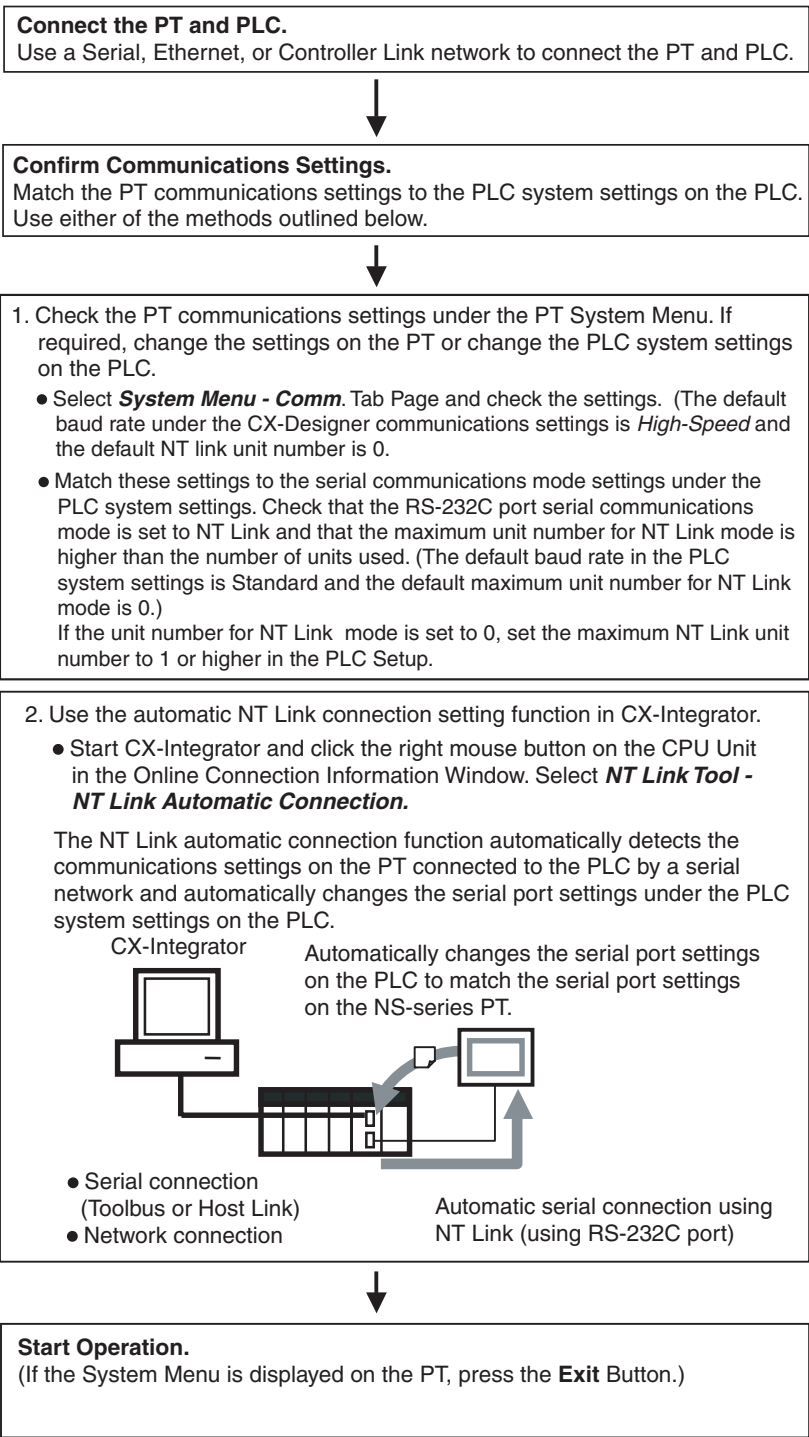

Refer to 6-10 Starting Operation in the NS Series Setup Manual.

SECTION 2

Setting Up the CX-Designer

The CX-Designer must be installed on the computer before it can be used for the first time. The CX-Designer is application software that runs on a Windows operating system.

2-1	Preparations for Installation	12
2-2	Installing USB Drivers for NS-Series PTs.....	13

2-1 Preparations for Installation

CX-Designer is included in CX-One and Sysmac Studio. For the installing method, refer to the manual for each software.

System Requirements

The system requirements for the CX-Designer conform to that of CX-One and Sysmac Studio.

Note

- (1) An RS-232C or USB port is required to connect to the NS-series PT.
- (2) The following restrictions apply when using CX-Designer or Windows OS other than Windows XP.

Some help files cannot be referenced.

Help files can be referenced if the help program (WinHlp32.exe) (distributed by Microsoft Corporation) is imported. For details, either refer to the Microsoft home page below or contact Microsoft Corporation. (When connected online, the download page is displayed automatically by opening the help file.)

<http://support.microsoft.com/kb/917607/en>

- (3) Refer to the How to manage after conversion file in the Programs Folder under the Windows Start Menu for details after NT31C/NT631C Conversion Support Tool conversion.

Using CX-Designer Windows OS other than Windows XP

The following restrictions apply when using CX-Designer Windows OS other than Windows XP.

Item	Contents
Fonts	If the project using TrueType font between the Windows with different OS versions is edited, it may cause a change with the font or character size.
Memory Card Transfer Support Software	Two-bytes characters used in file names and folder names on the Memory Card will not be displayed normally.

The folder structure after installation is as follows:

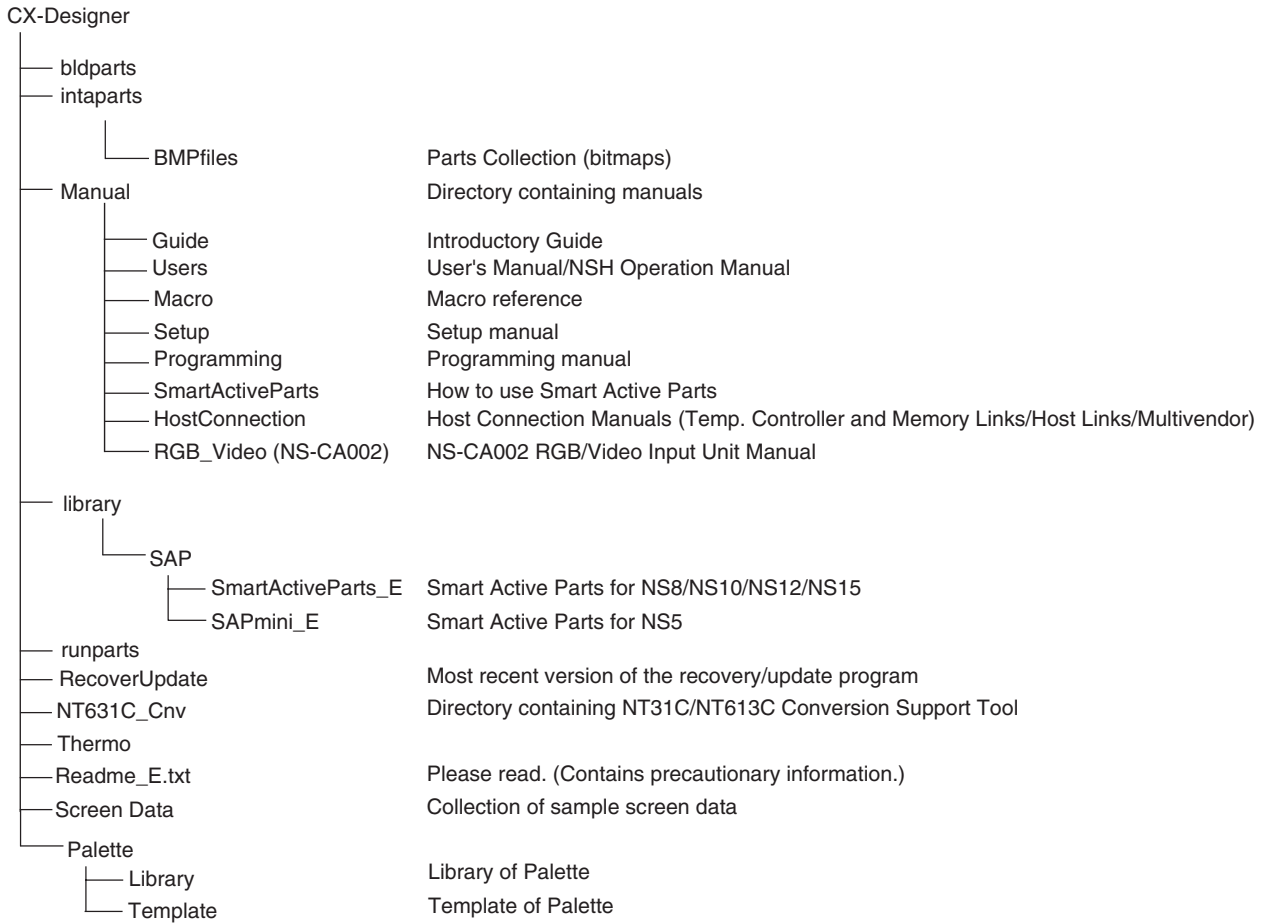

2-2 Installing USB Drivers for NS-Series PTs.

When CX-One or Sysmac Studio is installed, the NS series USB driver will be installed automatically. After installation, data can be transferred between the personal computer and NS-series PT via USB.

- Note**
- (1) With NS-V1 Series models, make sure that the PT has a lot number that supports USB transmission. The system program version of the NS-series PT must also support USB transmission. For details, refer to 3-3-2 *Connecting via USB in the NS series Setup Manual* (Cat. No. V083).
 - (2) Do not install the NS-series USB driver for the NS-Designer while the CX-Designer is being used.

SECTION 3

Basic Operations of the CX-Designer

This section describes basic functions and operation methods, such as starting and exiting CX-Designer and the user interface.

3-1	Starting and Exiting CX-Designer	16
3-1-1	Startup Method	16
3-1-2	Exiting CX-Designer	16
3-2	Menu Commands	17
3-3	User Interface	24
3-3-1	Names of Basic Screen Components	24
3-3-2	CX-Designer Functions and Screens	31

3-1 Starting and Exiting CX-Designer

This section describes how to start and exit the CX-Designer.

3-1-1 Startup Method

To start the CX-Designer, click the Windows **Start** Button, and then select **Programs - OMRON - CX-One - CX-Designer - CX-Designer** (The items displayed may vary according to the program folder specified during installation). Alternatively, right-click the NS-series PT in the Network Configuration Window of CX-Integrator, and select **Start Special Application - Start Only**. When the CX-Designer startup is completed, the Main Window will be displayed, as follows:

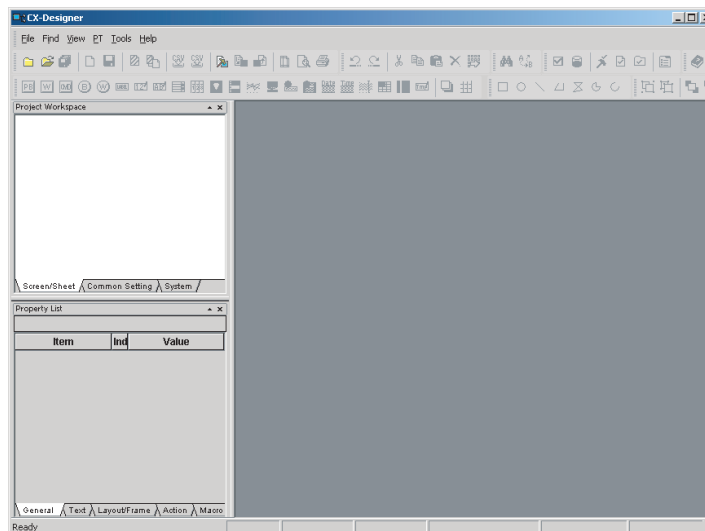

- Note**
- (1) More than one copy of the CX-Designer application can be run at the same time.
 - (2) To start CX-Designer, log in as the administrator.
 - (3) When Windows 8 is running, the CX-Designer startups from the startup screen.

3-1-2 Exiting CX-Designer

Use one of the following operations to exit the CX-Designer.

- Select **Exit** from the File Menu.
- Click the **Close** Button  at the top right of the Main Window.
- Double-click the CX-Designer icon at the top left of the Main Window.
- Click the CX-Designer icon at the top left of the Main Window and select **Close** from the Control Menu Box.
- Press the Alt + F4 Keys.

If the project data that is open has not been saved, a confirmation message will be displayed.

When the CX-Designer is exited, the system will return to the Windows display.

3-2 Menu Commands

The commands that appear on the pull-down menus of the CX-Designer and their functions are described in the following tables.

File Menu

Command	Function	Shortcut keys
New Project	Creates a new project.	---
Open Project	Opens an existing project.	---
Close Project	Closes the project currently open without exiting the CX-Designer.	---
Save Project As	Saves the current project under a specified name.	---
Save All	Saves (overwrites) all of the data for the current project.	Ctrl+S
New Screen	Creates a new screen under the current project.	Ctrl+N
Open Screen	Opens the project workspace.	Ctrl+O
Save Screen/Sheet	Saves the current screen or sheet.	Ctrl+Shift+S
New Sheet	Creates a new sheet under the current project.	Ctrl+Shift+N
Apply Sheet	Sets a screen with overlapping sheets.	Ctrl+J
Import CSV File	Imports project or screen data saved in CSV format to the current project or screen.	---
Export CSV File	Exports the current project or screen data to a file in CSV format.	---
Page Setup	Makes the printer settings.	---
Preview	Shows a preview of the printed image.	---
Print	Outputs current project or screen information to a printer or to a file. Select Print to display a preview.	Ctrl+P
Data Transfer Security		
New Data Transfer Security Setting	Sets a password to be input when transferring data.	---
Change Data Transfer Security Setting	Changes data transfer security setting.	---
Cancel Data Transfer Security Setting	Deletes data transfer security setting.	---
Recent Projects	Displays a list of currently edited projects. (Up to ten projects are displayed.)	---
Exit	Ends the CX-Designer.	---

Edit Menu

Command	Function	Shortcut keys
Undo	Discards changes and restores the previous status.	Ctrl+Z
Redo	Restores the changes discarded with Undo .	Ctrl+Y
Cut	Deletes the selected objects and places them in the internal buffer.	Ctrl+X, Shift+DEL
Copy	Copies the selected objects and places them in the internal buffer.	Ctrl+C
Paste	Pastes objects that have been cut or copied.	Ctrl+V, Shift+Ins
Paste (Style Only)	Pastes objects that have been cut or copied using the default address settings.	---
Delete	Deletes the selected objects.	DEL
Group		
Group	Groups more than one functional or fixed object to create a single object.	Ctrl+G
Ungroup	Ungroups grouped objects.	Ctrl+U
Order		
Front	Brings the currently selected object to the front.	---
Back	Sends the currently selected object to the back.	---
Bring Forward	Brings the currently selected object forward.	---
Send Backward	Sends the currently selected object back.	---
Align/Distribute		
Align Left	Aligns the currently selected objects to the left.	---
Center in a Column	Aligns the vertical centers of the currently selected objects.	---
Align Right	Aligns the currently selected objects to the right.	---
Align Top	Aligns the currently selected objects to the top.	---
Center in a Row	Aligns the horizontal centers of the currently selected objects.	---
Align Bottom	Aligns the currently selected objects to the bottom.	---
Distribute Horizontally	Distributes the currently selected objects equidistant (between mid-points) horizontally.	---
Distribute Vertically	Distributes the currently selected objects equidistant (between mid-points) vertically.	---
Make Same Size		
Smallest Width	Aligns the currently selected objects to the smallest width.	---
Largest Width	Aligns the currently selected objects to the largest width.	---
Smallest Height	Aligns the currently selected objects to the smallest height.	---
Largest Height	Aligns the currently selected objects to the largest height.	---
Table Column Width	Aligns table columns to equal widths.	---
Table Row Height	Aligns table rows to equal heights.	---

Command	Function	Shortcut keys
Nudge		
Up	Moves the selected object one dot or one grid unit up.	↑
Down	Moves the selected object one dot or one grid unit down.	↓
Left	Moves the selected object one dot or one grid unit to the left.	←
Right	Moves the selected object one dot or one grid unit to the right.	→
Rotate/Flip		
Rotate Right 90 Degrees	Rotates the currently selected object 90 degrees to the right.	---
Rotate Left 90 Degrees	Rotates the currently selected object 90 degrees to the left.	---
Rotate Right 90 Degrees Around Center of Screen/ Frame	Rotates the currently selected object 90 degrees to the right around the center of the screen or frame.	---
Rotate Left 90 Degrees Around Center of Screen/ Frame	Rotates the currently selected object 90 degrees to the left around the center of the screen or frame.	---
Flip Horizontal	Flips the currently selected object horizontally.	---
Flip Vertical	Flips the currently selected object vertically.	---
Flip Horizontal Around Center of Screen/ Frame	Flips the currently selected object horizontally around the center of the screen or frame.	---
Flip Vertical Around Center of Screen/ Frame	Flips the currently selected object vertically around the center of the screen or frame.	---
Edit Node	Changes the positions of the vertices to change the shape of a fixed object node.	---
Select All		
All Objects	Selects all objects on the screen.	Ctrl+A
Same Type Objects	Selects all objects of the same type as the currently selected object.	Ctrl+D
Repeat	Makes multiple copies of the selected objects.	Ctrl+W
Edit Properties	Displays a list of functional objects on screen to enable changing property settings.	Ctrl+L

Find Menu

Command	Function	Shortcut keys
Find	Searches for address or character string keywords.	Ctrl+F
Replace	Replaces the specified addresses.	Ctrl+H
Address Cross Reference	Finds locations where an address is used and lists the results.	Ctrl+R
Macro Cross Reference	Lists macro locations.	---
Replace Host	Replaces the host for all addresses in the project.	---

View Menu

Command	Function	Shortcut keys
Toolbar	Displays and hides the toolbar.	---
Window		
Project Workspace	Displays and hides the project workspace.	Alt+1
Symbol Table	Displays and hides the symbol table.	Alt+2
Property List	Displays and hides the property list.	Alt+3
Library	Displays and hides the Library Window.	Alt+4
Select Object	Displays and hides the object selection.	Alt+5
Address in Use List	Displays and hides the List Up Addresses Used Window.	Alt+6
Output Window	Displays and hides the Output Window.	Alt+7
Palette	Displays and hides the Palette Window.	Alt+8
Status Bar	Displays and hides the Status Bar.	---
Previous Label	Displays the previous label.	Ctrl+PgUp
Next Label	Displays the next label.	Ctrl+PgDn
Previous Screen	Displays the previous screen.	Shift+PgUp
Next Screen	Displays the next screen.	Shift+PgDn
Previous Frame Page	Displays the previous frame page.	PgUp
Next Frame Page	Displays the next frame page.	PgDn
Show Address		
Show Symbol Name	Switches to functional object display showing symbol names.	---
Show Address	Switches to functional object display showing addresses.	---
Show I/O Comment	Switches to functional object display showing I/O comments.	---
Hide	Switches to functional object display hiding addresses.	---
Show ID	Displays and hides ID numbers for objects.	---
Simulate ON/OFF	Switches ON and OFF display for functional objects.	---
Show Sheet Object	Displays and hides objects registered in sheets.	---
Grid	Sets the grid.	---
Show Touch Points	Displays and hides the locations of touch points on the PT when editing a project for an NS-series PT (except for the NS15).	---
Zoom	Zooms the display in and out.	---
Refresh	Redraws the screen.	F9

PT Menu

Command	Function	Shortcut keys
Transfer		
Quick transfer (Computer → PT)	Compares project data with data in the PT and transfers only refreshed data to the PT.	Ctrl+Q
Transfer (Computer → PT)	Transfers all project data to the PT.	Ctrl+B
Transfer (PT → Computer)	Uploads the project data stored in the PT to the computer.	Ctrl+Shift+B
Transfer Setting	Sets the communications path to be used in the transfer.	Ctrl+Alt+B
Transfer Program	Starts the tool for transferring project data created on the CX-Designer to the PT or receive project data from the PT to the CX-Designer.	Ctrl+I
System Setting	Sets the PT operating parameters. (This is the same as double-clicking System Setting on the project workspace System Tab Page.)	---
Project Properties	Sets the project properties. (This is the same as double-clicking Project Properties on the project workspace System Tab Page.)	---
Communication Setting	Registers hosts and sets communications conditions. (This is the same as double-clicking Communication Setting on the project workspace System Tab Page.)	---
Alarm/Event Setting	Registers and corrects alarms and events. (This is the same as double-clicking Alarm/Event Setting on the project workspace Common Setting Tab Page.)	---
Data Log Setting	Registers and corrects the data log function. (This is the same as double-clicking Data Log Setting on the project workspace Common Setting Tab Page.)	---
Broken-line Graph Group Setting	Registers and corrects broken-line graph groups. (This is the same as double-clicking Broken-line Graph Group Setting on the project workspace Common Setting Tab Page.)	---
Data Block Setting	Registers and corrects data blocks. (This is the same as double-clicking Data Block Setting on the project workspace Common Setting Tab Page.)	---
Document Table Setting	Used to register or correct document files displayed for document display objects. Used only with NS-Runtime.	---
String Table Setting	Used to register or correct character strings in character tables. (This is the same as double-clicking String Table Setting on the project workspace Common Setting Tab Page.)	---
Device Data Transfer Setting	Used to register and correct entries and groups in device data transfer settings. (This is the same as double-clicking Device Data Transfer Setting on the project workspace Common Setting Tab Page.)	---
Troubleshooting setting	Used to make settings for the NJ/NX-series Troubleshooter. (This is the same as double-clicking Troubleshooter Setting on the project workspace Common Setting Tab Page.)	---

Command	Function	Shortcut keys
Password	Sets the password. (This is the same as double-clicking Password on the project workspace Common Setting Tab Page.)	---
Unit/Scale	Sets the units and scales used by numeral objects. (This is the same as double-clicking Unit/Scale on the project workspace Common Setting Tab Page.)	---
Dialog Setting	Sets the dialog displayed when functional objects are pressed.	---
Flicker	Sets flicker settings for each screen or sheet.	---
Color Transparent	Sets transparent colors for bitmap files set in the project.	---
Operation Log Setting List Display	Displays the operation log settings in a list format.	---
Screen/Sheet Properties	Sets the screen properties.	---
Change Input Order	Sets the order for shifting the focus for numeral and text input objects on the screen.	---
Edit Contents	Sets switching the contents of individual screens and sheets.	---
Object Properties	Sets the properties for the currently selected functional object.	Enter
Edit Label	Enables direct editing of functional object labels on the screen without opening a property dialog box.	Space

Functional Objects Menu

Command	Function	Shortcut keys
ON/OFF Button	Starts creation of an ON/OFF button.	---
Word Button	Starts creation of a word button.	---
Command Button	Starts creation of a command button.	---
Bit Lamp	Starts creation of a bit lamp.	---
Word Lamp	Starts creation of a word lamp.	---
Multifunction	Starts creation of a Multifunction Object.	---
Label	Starts creation of text.	---
Numeral Display & Input	Starts creation of a Numeral Display & Input Object.	---
String Display & Input	Starts creation of a String Display & Input Object.	---
List Selection	Starts creation of a List Selection object.	---
Thumbwheel Switch	Starts creation of a thumbwheel switch.	---
Analog Meter	Starts creation of an analog meter.	---
Level Meter	Starts creation of a level meter.	---
Broken-line Graph	Starts creation of a broken-line graph.	---
Bitmap	Starts creation of a bit map.	---
Alarm/event Display	Starts creation of an alarm/event display object.	---
Alarm/Event Summary & History	Starts creation of an alarm/event summary & history object.	---
Date	Starts creation of a date object.	---
Time	Starts creation of a time object.	---
Data Log Graph	Starts creation of a data log graph.	---
Data Block Table	Starts creation of a data block table.	---

Command	Function	Shortcut keys
Video Display	Starts creation of a video display object.	---
Temporary Input	Starts creation of a temporary input.	---
Consecutive Line Drawing	Starts creation of a continuous line.	---
Document Display	Selects document display and starts creation of a screen. Document display is supported for NS-Runtime only.	---
Contents Display	Starts creation of a contents display.	---
Frame	Starts creation of a frame region.	---
Table	Starts creation of a table on a table creation screen.	---

Fixed Objects Menu

Command	Function	Shortcut keys
Rectangle	Starts creation of a rectangle.	---
Circle•Oval	Starts creation of a circle or oval.	---
Straight Line	Starts creation of a straight line.	---
Polyline	Starts creation of a continuous straight line.	---
Polygon	Starts creation of a polygon.	---
Sector	Starts creation of a pie-shaped sector.	---
Arc	Starts creation of an arc.	---

Tools Menu

Command	Function	Shortcut keys
Test	Performs an operating test on the computer. The test can be performed while connected to either the CX-Simulator (virtual PLC) or an actual PLC. (CX-Designer version 2.0 or higher.)	Ctrl+T
PLC Error Simulator	Starts the PLC error simulator. For details on the PLC error simulator, refer to the <i>CX-Programmer Operation Manual</i> (Cat. No. W446). This command cannot be used if the host is an NJ/NX-series Controller.	---
Resource Report	Displays a report on the resources that have been used.	---
Validation		
Validation (Project)	Checks all screen data in the project according to validation settings to see if any mistakes have been made.	Ctrl+E
Validation (Current Screen)	Checks screen data displayed at the front according to validation settings to see if any mistakes have been made.	Ctrl+Shift+E
Validation Setting	Sets the project data check items.	Ctrl+Alt+E
DXF Explorer	Starts the tool for accessing DXF files using the CX-Designer.	---
Library	Displays the Library Window to enable pasting objects registered in the library on the screen. Also enables registering objects on the screen in the library.	Alt+4
Import Old Library	Converts a library created on NS-Designer for use with CX-Designer.	---

Command	Function	Shortcut keys
Conversion		
Version	Changes the system version of the project currently being edited. (You cannot convert to a system version lower than what is currently being edited.)	---
Model	Changes the model of the NS-series PT for the project currently being edited.	---
Reset Defined Default		
Functional Object	Resets functional object specified values to default values.	---
Fixed Objects	Resets fixed object specified values to default values.	---
Option	Sets optional functions for editing screens.	---

Window Menu

Command	Function	Shortcut keys
Next Window	Moves to the next window of the windows displayed under View - Window .	Alt+0
Previous Window	Moves to the previous window of the windows displayed under View - Window .	Alt+Shift+0
Close All	Closes all open screen editing windows.	---
Cascade	Cascades the screen editing windows.	---
Tile	Tiles the screen editing windows.	---
Arrange Icons	Arranges the minimized window icons.	---
Window List	Lists all open screen editing windows. The front screen will have a check mark by it.	---

Help Menu

Command	Function	Shortcut keys
Contents	Displays the contents for the online help.	---
Search Topic	Displays a search dialog box for help topics.	---
Online Registration	Registers the user online.	---
About CX-Designer	Displays information on the product.	---

3-3 User Interface

3-3-1 Names of Basic Screen Components

The configuration and names and functions of the components in the CX-Designer operation screen are described here.

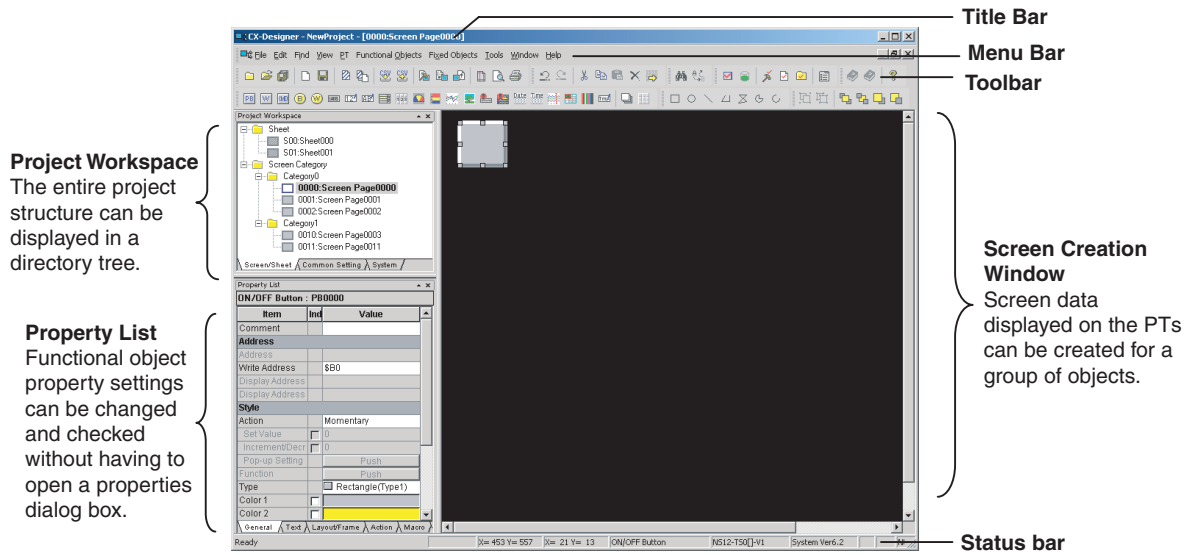

Title Bar

The title bar displays the application name, project name, and screen number.

Menu Bar

The menu bar provides groups of related functions.

Each group name is displayed in the menu bar and the functions are displayed on pull-down menus under each group name.

Project Workspace

The project screen data and settings are displayed in a tree hierarchy in the project workspace.

Screens and sheets can be created, copied, and deleted in the project workspace.

Screens from different projects can be copied between workspaces if more than one copy of CX-Designer is running at the same time.

The project workspace can be displayed and hidden by selecting **View - Window - Project workspace**.

A list of the created screens and sheets will be displayed on the Screen/Sheet Tab Page.

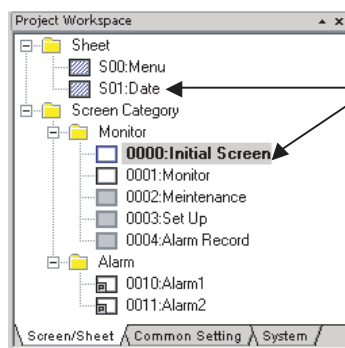

Double-click on any screen or sheet to open it. Screens and sheets can be created, copied, and deleted.

The Common Setting Tab Page displays the common settings browsed by all functional objects.

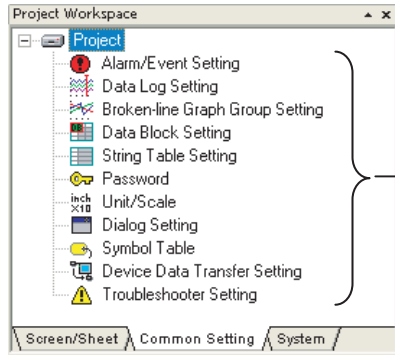

Double-click any item to open the settings dialog box.

The System Tab Page displays the project and communications settings.

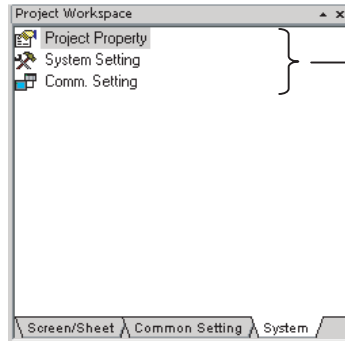

Double-click on any item to open the settings dialog box.

Property List

Property Lists display the property settings for the functional object selected on the screen. Settings can be checked and changed without opening a Property Setting Dialog Box.

Changes to properties made on the Property List are immediately reflected on the screen, which enables changes to be checked during screen creation.

Property Lists can be displayed and hidden by selecting **View - Window - Property List**.

Enables display and settings of properties of the selected object without opening a property dialog box.

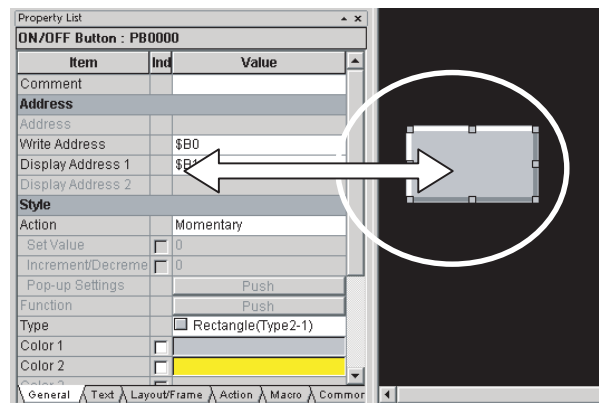

■ **Global Replace**

More than one object can be selected and the common settings for those objects can be changed in one operation.

The following example shows a global change of the object color.

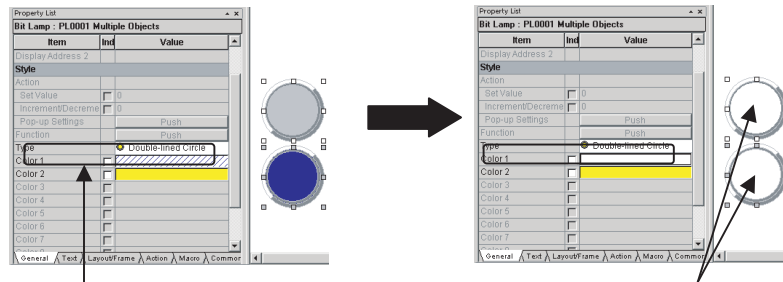

The two objects on the screen for which the color is to be changed are selected and **Color 1** is changed.

The color for the two selected objects is changed in the one operation.

Screen Creation Window

Screens displayed on the PTs can be created using functional and fixed objects.

Status bar

The Status Bar can be displayed and hidden by selecting **View - Status Bar**.

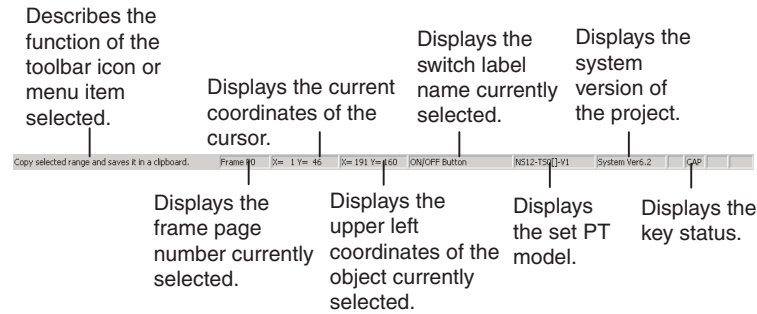

Toolbar

Each toolbar can be displayed and hidden according to the settings in the Customize Dialog Box displayed under **View - Toolbar**.

■ **File Toolbar**

Displays functions relating to file operation, such as creating or saving projects and screens and transferring project data, as icons.

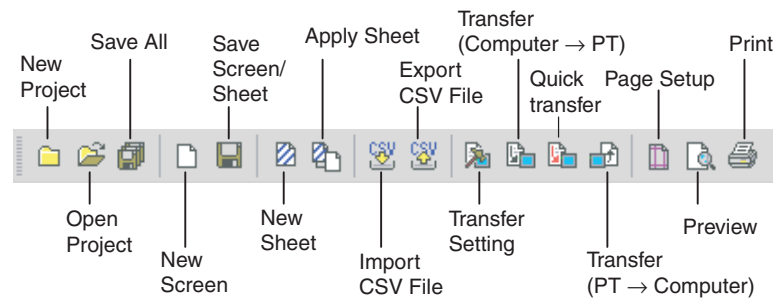

■ **Edit Toolbar**

Displays functions relating to editing objects, such as copy, cut, and paste as icons.

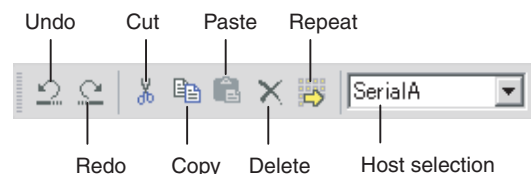

■ **Find Toolbar**

Displays functions relating to searching and replacing as icons.

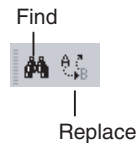

■ **Tool Toolbar**

Displays frequently used functions from the Tools Menu as icons.

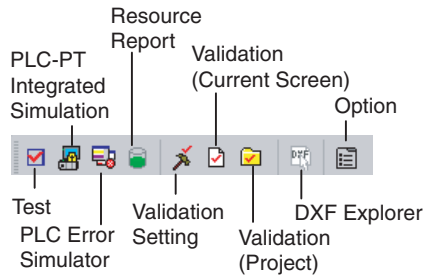

■ **Help Toolbar**

Displays help and version information functions as icons.

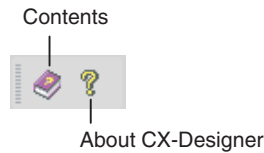

■ **Functional Object Toolbar**

Displays screen creation functions for functional objects as icons.

Select the icon button of the functional object to be used to start screen creation.

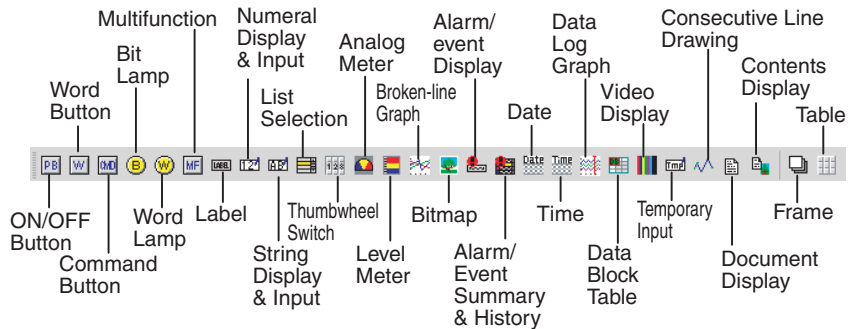

Note Document display is supported for NS-Runtime only.

■ **Fixed Object Toolbar**

Displays fixed object drawing functions as icons.

Select the icon button of the fixed object to be used to start drawing screens.

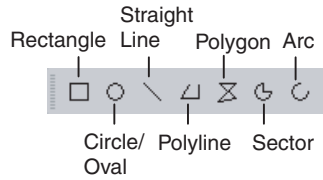

■ **Grouping Order Toolbar**

Displays object grouping and change distribution order functions as icons.

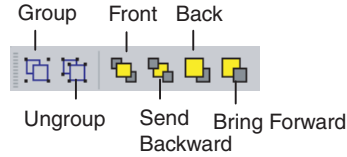

■ **Edit Objects Toolbar**

Displays functions relating to changing object layout and object alignment as icons.

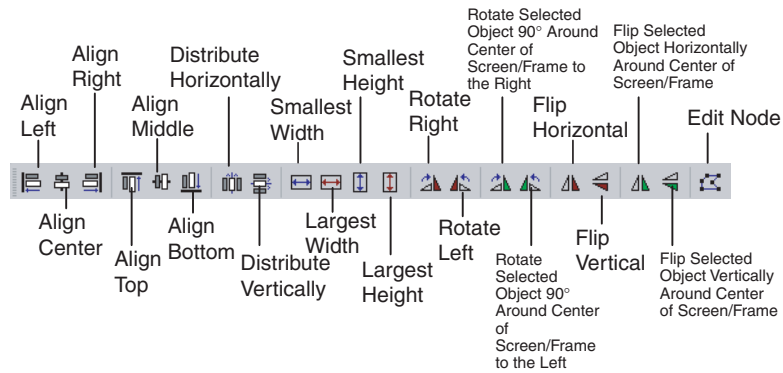

■ **Window Display Toolbar**

Displays functions for displaying windows as icons.

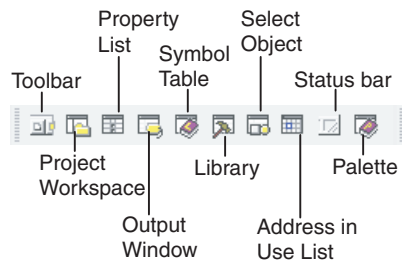

■ **Switch Toolbar**

Displays functions for switching labels, screens, and frame pages as icons.

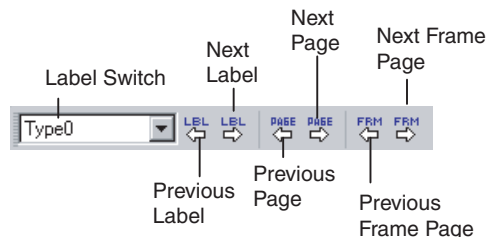

■ **View Toolbar**

Displays functions for switching the Screen Creation Window display as icons.

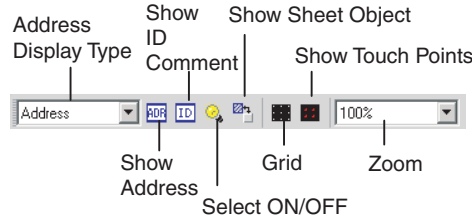

■ **Font Toolbar**

Displays the functions for setting text font properties in functional objects as icons.

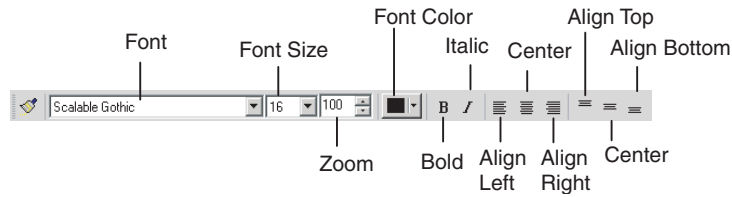

■ **Color Toolbar**

Displays the color settings for functional objects and fixed objects as icons.

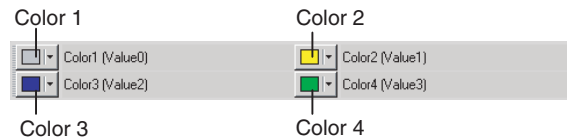

■ **Address Toolbar**

Displays the setting functions for the addresses of the functional objects in a toolbar. Select the functional object for which the address is to be set and set the address.



■ **Edit Contents Toolbar**

Sets the basic contents change settings required for using the Machine Navigator. By changing the contents number, the display can be changed to the contents set for that contents number.

Click the **Edit Contents** Button to display the Edit Contents Dialog Box. Detailed settings can then be made for changing contents.

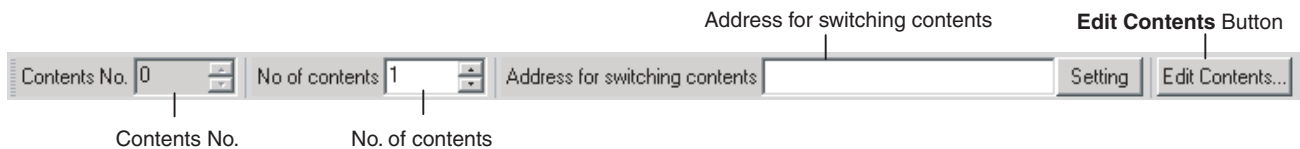

Output Window

The Output Window displays various data such as CX-Designer search, data check, and other processing results and error details.

The Output Window can be displayed and hidden by selecting **View - Window - Output Window**.

The Output Tab Page displays the CX-Designer operating status and error information.

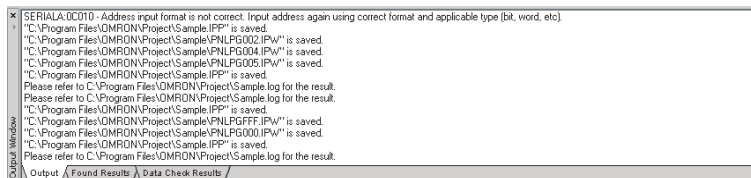

The Found Results Tab Page displays the search and replace results. Click an item to display and select the corresponding object.

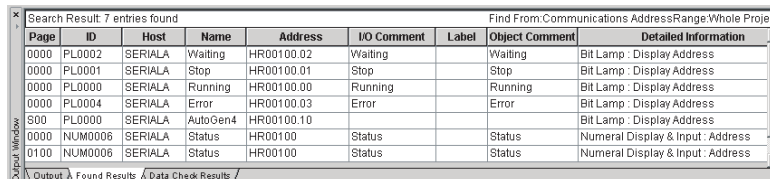

The Data Check Results Tab Page displays the data check results. Click an item to display and select the corresponding object.

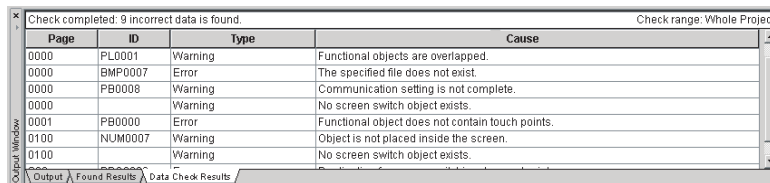

3-3-2 CX-Designer Functions and Screens

Symbol Table

A symbol table lists the symbols registered to the project.

The CX-Designer can specify symbols as the data to be accessed by functional objects, in addition to directly specifying PLC or other host addresses or internal memory.

“Symbol” is a name to which an address is allocated. This symbol can be used instead of the address in the CX-Designer. This allows addresses to be changed simply by changing the address set for the symbol, instead of opening each screen and changing the property settings for the functional objects on that screen. In addition, comments can be specified for symbols in the CX-Designer.

The Symbol Table Window can be displayed and hidden by selecting **View - Window - Symbol Table** from the menu bar.

Click **Name** to change the display order between descending and ascending (the sort function).

Click to display a pull-down list and display only the desired type (the filter function).

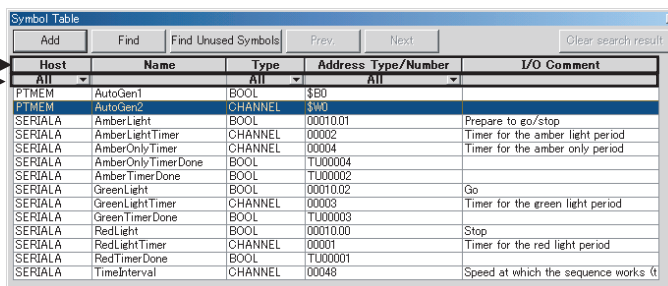

- Note**
- (1) Symbols can be added or deleted and functions that use a symbol can be searched for in the symbol table.
 - (2) Symbols (communications addresses) to be set can be copied from the symbol table to the Property List using the drag-and-drop function.
 - (3) Symbols can also be copied from the CX-Programmer's symbol table or variables can be copied from the Sysmac Studio's variable table and then pasted to the CX-Designer's symbol table. This enables the same symbols/variables to be used by both the CX-Designer and the CX-Programmer or Sysmac Studio.

Library Window

A library object is a group of registered functional and fixed objects together with their property settings registered as one unit of data.

Objects can be registered as a library object and easily reused in multiple locations or screens from the Library Window.

The Library Window can be displayed and hidden by selecting **View - Window - Library**.

Objects can be easily registered and reused, using the drag-and-drop function.

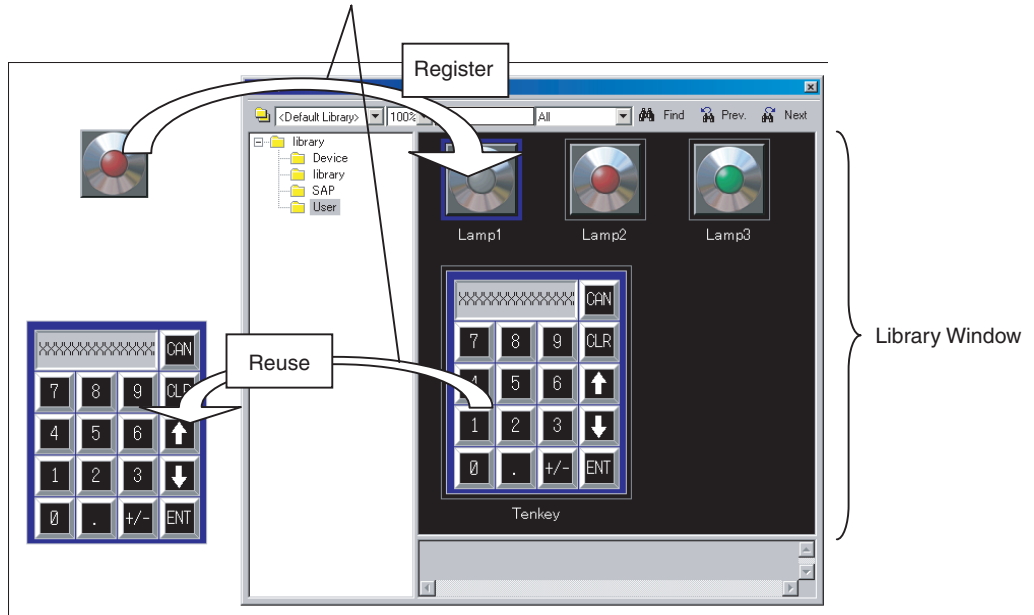

Object List Window

The Object List Window lists the functional objects located in Screen Creation Window.

Any object can be selected and the display on the Screen Creation Window can be restricted to a specified type of functional object from the Select Object Window.

Selecting and displaying objects by type enables easy editing of objects hidden under other objects. Normal screen editing is also possible in this mode.

The Select Object Window can be displayed and hidden by selecting **View - Window - Object List**.

Screen Creation Window

Define Origin	OFF	ON	
Search Origin	OW	OCW	Search/Return Initial Speed
Detection Method	Meth.	9	999999pps
Search Operation	Inv. 1	Inv. 2	Search High
Operation	Mode	9	999999pps
D.Input Signal	NC	NO	Search Prox. Speed
P.Input Signal	NC	NO	999999pps
L.Input Signal	NC	NO	S.Compensation Val.
P.Monitor Time	99999	99999	9999999999
Search A.Ratio	99999		
Search D. Ratio	99999	READ	WRITE

O	Object Comment	ID	X	Y
PB		PB0002	118	103
PB		PB0003	168	103
PB		PB0063	178	303
PB		PB0064	258	303
W	Enable Input	PBW0006	118	123
W	Enable Input	PBW0008	168	123
W	Enable Input	PBW0011	118	143
W	Enable Input	PBW0016	118	163
W	Enable Input	PBW0018	168	163

Select Object Screen Lists objects on the screen.

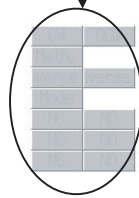

Label objects that were hidden underneath

O	Object Comment	ID	X	Y
LBL	Disable Input	LBL0005	118	123
LBL	Disable Input	LBL0007	168	123
LBL	Disable Input	LBL0010	118	143
LBL	Disable Input	LBL0015	118	163
LBL	Disable Input	LBL0017	168	163
LBL	Disable Input	LBL0020	118	183
LBL	Disable Input	LBL0025	118	203
LBL	Disable Input	LBL0027	168	203
LBL	Disable Input	LBL0030	118	223

Select only **Label** to display labels that were hidden under other objects. Labels can also be edited in this mode.

Address in Use List

Displays a list of the number of times each address is used in functional objects.

A list of the functional objects using the addresses is also displayed in the Output Window and specified functional objects can be selected on the screen.

The Address in Use Window can be displayed and hidden by selecting **View - Window - Address in Use List**.

Displays the addresses.

Sets the start address for the search range.

Start Address:	SERIALA:00000.00	Set...	Go													
No. of Display Lines:	10	Save...														
Whole Project	Detail	Find Reference Object														
	+0	+1	+2	+3	+4	+5	+6	+7	+8	+9	+10	+11	+12	+13	+14	+15
SERIALA:00000.00	8	8	8	8	8	8	8	8	8	8	1	1	1	1	1	0
SERIALA:00001.00	1	1	1	1	1	1	1	1	1	0	0	0	0	0	0	0
SERIALA:00002.00	1	1	1	1	1	1	1	1	1	0	0	0	0	0	0	0
SERIALA:00003.00	1	1	1	1	1	1	1	1	1	1	1	1	1	1	1	1
SERIALA:00004.00	0	0	0	0	0	0	0	0	0	0	0	0	0	0	0	0
SERIALA:00005.00	0	0	0	0	0	0	0	0	0	0	0	0	0	0	0	0
SERIALA:00006.00	0	0	0	0	0	0	0	0	0	0	0	0	0	0	0	0
SERIALA:00007.00	0	0	0	0	0	0	0	0	0	0	0	0	0	0	0	0
SERIALA:00008.00	0	0	0	0	0	0	1	1	1	1	0	0	0	0	0	0
SERIALA:00009.00	5	5	5	5	5	5	5	5	5	5	5	5	5	5	5	5

Sets the search range.

Displays the number of times each address is used. (Unused addresses are displayed in gray.)

SECTION 4

Useful Functions

This section describes useful CX-Designer functions for creating project data and debugging and how to use these functions.

4-1	Creating Screens Using Symbols	36
4-1-1	Changing Allocated Addresses.	36
4-1-2	Reusing Existing Projects in Another System	37
4-1-3	Copying and Pasting Symbols/Variables between Support Software.	37
4-1-4	Using I/O Allocation Table in Symbol Table	39
4-1-5	Creating Screens Using Symbol Names and Then Setting Addresses	40
4-2	Using Screens from Other Projects.	40
4-3	Classifying Screens by Application	42
4-3-1	Creating Categories	43
4-3-2	Moving Screens between Categories	44
4-3-3	Creating New Screens.	44
4-4	Checking and Changing Functional Object Properties without Opening Property Setting Dialog Boxes	44
4-4-1	Globally Replacing Settings for More Than One Object	45
4-5	Listing and Editing Functional Object Properties.	45
4-5-1	Setting Consecutive Addresses.	46
4-5-2	Copying the Same Setting to More Than One Cell	46
4-6	Editing Overlapping Objects.	47
4-6-1	Method for Selecting Specified Objects.	47
4-6-2	Displaying Only Specified Objects on a Screen.	48
4-7	Creating Multi-language Labels	48
4-8	Checking Address Usage Status	49
4-9	Searching for Embedded Macros	50
4-10	Transferring Only Edited Data to PT	51
4-11	Creating Documents	52
4-12	How to Use Help.	53
4-13	Integrated Simulation for the Entire System.	54
4-13-1	Debugging Screens and the User Program with a Virtual PLC	54
4-13-2	Debugging Screens and the User Program with the Actual PLC.	57
4-14	Setting Security for Data Transfers with the PT	58
4-15	Setting Symbol Names and I/O Comments for Use as Labels	59
4-16	Executing Multiple Functions with a Single Operation	61
4-17	Replacing a Lamp with a Button.	63
4-18	Creating Polygonal Lamps	65
4-19	Registering Contents	67
4-20	Using Machine Navigator.	69
4-21	Enlarging Objects Proportional to Screen Size during Data Conversion	73
4-22	Batch-setting Label Formats	74

4-1 Creating Screens Using Symbols

The CX-Designer can enter addresses as symbols when setting functional object addresses. (Addresses can also be directly input, the same as for the NS-Designer. Symbols are automatically allocated in these cases.)

This means that all addresses used in a project can be managed from the symbol table.

The following operations can be performed easily using the symbol table.

- Changing allocated addresses when the address allocation changes suddenly.
- Reusing existing projects in another system.

Symbols/variables can also be copied and pasted between the CX-Programmer's and CX-Designer's symbol tables and between the Sysmac Studio's variable table and the CX-Designer's symbol table.

Also, any I/O allocation table created using Excel or other software can be used as is in symbol tables.

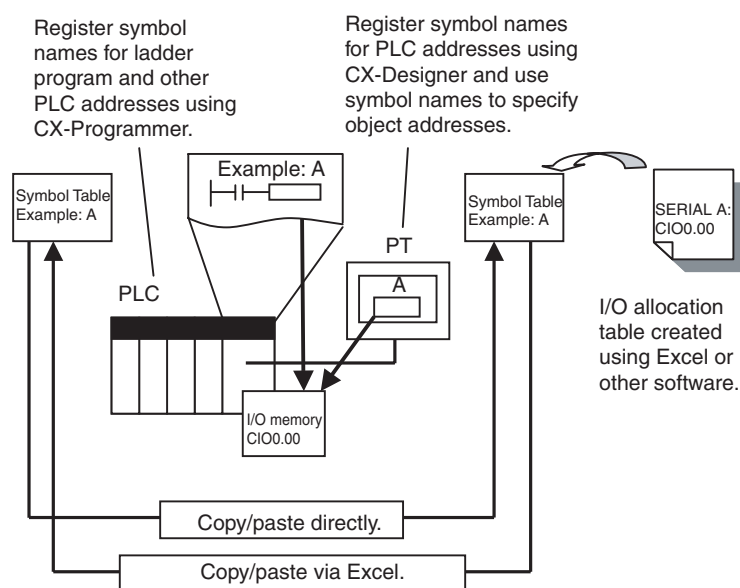

4-1-1 Changing Allocated Addresses

If an address allocated for a symbol is changed on a symbol table, the change is automatically reflected in all screens.

This allows allocated addresses to be changed simply by changing the symbol table, instead of opening each screen and changing the property settings for the functional objects on that screen.

There is flexibility with symbol changes to meet any requirement. The replace function can be used to globally replace the host and addresses. Symbols can also be changed individually.

Procedure

1. Select **Symbol Table** on the project workspace Common Setting Tab Page. The symbol table will be displayed.
2. Double-click the symbol for which the allocated address is to be changed in the symbol table.
3. Change the allocated address in the displayed Address Settings Dialog Box.

- When the changes have been completed, they will be reflected in all functional objects that use that symbol.

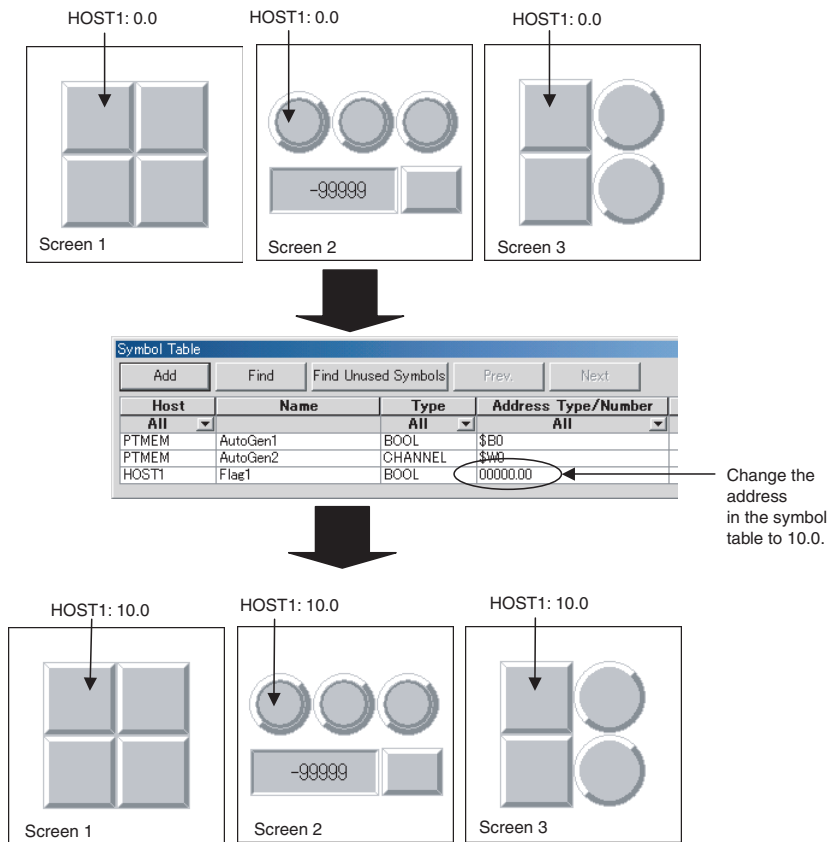

4-1-2 Reusing Existing Projects in Another System

When using existing projects in another system, the addresses allocated for objects can be easily changed simply by changing the addresses in the symbol table.

Procedure

- 1,2,3... 1. Change the allocated address for each symbol in the symbol table.
2. To replace addresses in the symbol table, right-click the mouse and select **Replace** from the pop-up menu that is displayed.

4-1-3 Copying and Pasting Symbols/Variables between Support Software

Both the CX-Designer and CX-Programmer have symbol tables and can share their symbol data. The Sysmac Studio has variable tables, and the variable data can be shared with the symbol data of the CX-Designer. (Symbol data and variable data are essentially the same.)

This means that variables/symbols can be copied between the different types of Support Software.

Name	Data Type	Address / Value	Rack Location	Usage	Comment
P_First_Cycle	BOOL	A200.11		Work	First Cycle Flag
P_Stop	BOOL	A200.12		Work	Stop Flag
P_First_Cycle_Task	BOOL	A200.15		Work	First Task Execution Flag
P_Max_Cycle_Time	UDINT	A262		Work	Maximum Cycle Time
P_Cycle_Time_Value	UDINT	A264		Work	Present Scan Time
P_Cycle_Time_Error	BOOL	A401.08		Work	Cycle Time Error Flag
P_Low_Battery	BOOL	A402.04		Work	Low Battery Flag
P_IO_Verify_Error	BOOL	A402.09		Work	I/O Verification Error Flag
P_Output_Off_Bt	BOOL	A500.15		Work	Output Off Bit



CX-Programmer symbols are copied and pasted to the CX-Designer symbol table.

Host	Name	Type	Address	Type/Number	I/O	Comment
All	All	All	All	All		
PTMEM	AutoGen1	BOOL	188			
PTMEM	AutoGen2	CHANNEL	190			
SERIALA	P_First_Cycle	BOOL	AR000011			First_Cycle
SERIALA	P_Stop	BOOL	AR000012			Stop
SERIALA	P_First_Cycle_Task	BOOL	AR000015			First_Cycle_Task
SERIALA	P_Max_Cycle_Time	CHANNEL	AR000262			Max_Cycle_Time
SERIALA	P_Cycle_Time_Value	CHANNEL	AR000264			Cycle_Time_Value
SERIALA	P_Cycle_Time_Error	BOOL	AR004018			Cycle_Time_Error
SERIALA	P_Low_Battery	BOOL	AR004024			Low_Battery
SERIALA	P_IO_Verify_Error	BOOL	AR004029			IO_Verify_Error
SERIALA	P_Output_Off_Bt	BOOL	AR005015			Output_Off_Bit



The same symbol as the CX-Programmer symbol is added.

Note

- (1) To use tags (network symbols), the same tags must be registered in both the PT and the host. If network variables (tags) are added or changed in either the CX-Designer or in the CX-Programmer or Sysmac Studio, copy them to the other Support Software. Tags are supported by CX-Programmer version 8.0 or higher and Sysmac Studio version 1.0 or higher.
- (2) When using a data structure in the CX-Designer, the members of the structure are registered individually and treated as separate symbols. If there are array members in the data structure, they can be used as arrays in the CX-Designer. If the data structure is registered as array, however, the elements must be registered individually and treated as separate symbols.
- (3) When using the Sysmac Studio and CX-Designer, you can copy and paste variables from the Sysmac Studio to the CX-Designer, but not from the CX-Designer to the Sysmac Studio.
- (4) To copy structure variables between the CX-Designer and CX-Programmer/Sysmac Studio, CX-Programmer version 9.2 or higher and Sysmac Studio version 1.0 or higher is required. Structure variables can be copied and pasted from the CX-Programmer or Sysmac Studio to the CX-Designer, but not from the CX-Designer to the CX-Programmer or Sysmac Studio.

Procedure

Copying Variables from the CX-Programmer or Sysmac Studio to the CX-Designer

1,2,3...

1. Start the CX-Programmer or Sysmac Studio and open the project that contains the variables to share.
2. Select the symbol from the CX-Programmer symbol table. For the Sysmac Studio, select **Tool – Export Global Variables – CX-Designer** to copy the variables.
3. Open the CX-Designer symbol table and paste the symbol.

- If a host address is set for the symbol, select the applicable host for the destination.

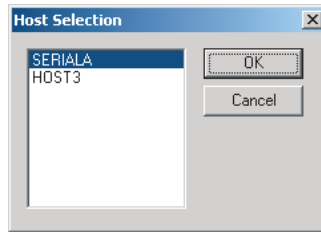

Copying CX-Designer Symbols to the CX-Programmer

1,2,3...

- Select the symbol from the CX-Designer symbol table and copy it to the CX-Programmer.

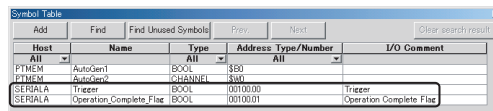

- Open the CX-Programmer symbol table and paste the symbol.

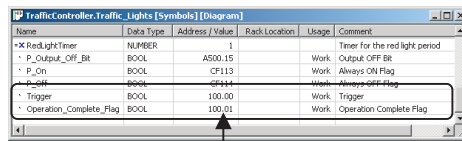

The same symbol as the CX-Designer symbol is added.

4-1-4 Using I/O Allocation Table in Symbol Table

The user can create the required I/O allocation table when creating projects. If the I/O allocation table is created in the same format as the symbol table, the I/O allocation table data can be copied as is to the symbol table. This enables symbols to be created easily from the I/O allocation table.

Host	Name	Type	Address	Comment
SERIAL A	Trigger	BOOL	100.00	Trigger
SERIAL A	Operation_Complete_Flag	BOOL	100.01	Operation Complete Flag
SERIAL A	Data_Area1	CHANNEL	DM1000	Data_Area1
SERIAL A	Data_Area2	CHANNEL	DM2000	Data_Area2
SERIAL A	Data_Area3	CHANNEL	DM3000	Data_Area3
SERIAL A	Alarm1	BOOL	WR200.0	Alarm1
SERIAL A	Alarm2	BOOL	WR200.1	Alarm2
SERIAL A	Alarm3	BOOL	WR200.2	Alarm3

Copy the I/O allocation table created using Excel and past to the CX-Designer symbol table.

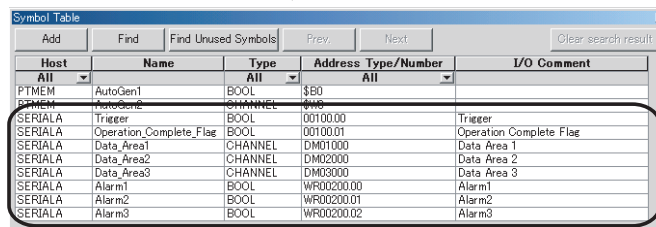

The I/O allocations in the table are registered as symbols.

Procedure

1,2,3...

- Create an I/O allocation table using Excel. Use the following order in the I/O allocation table: Host, symbol name, type, address, and I/O comment
- Copy the I/O allocation table.

- Open the CX-Designer symbol table and paste the symbols.

4-1-5 Creating Screens Using Symbol Names and Then Setting Addresses

Screens can be created using only symbol names even if addresses are not set. When the addresses are later determined, they can be input collectively in the symbol table. In addition, if an address allocated as a symbol in the symbol table is changed, that change is reflected in all functional objects where that symbol is set.

Procedure

- 1,2,3... 1. Input the symbol names for the communications address setting locations for the functional object.

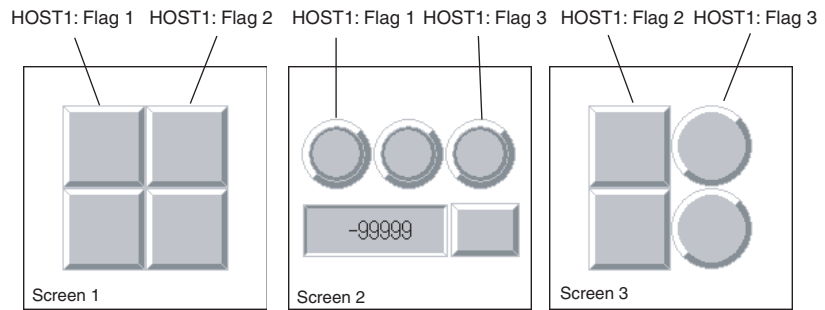

2. Set or change the addresses for the symbols input from the symbol table in step 1.

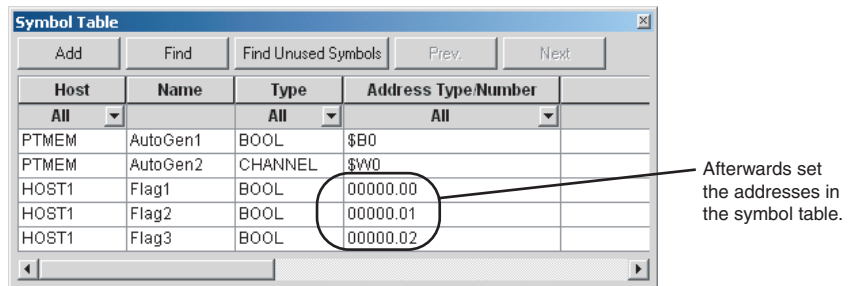

3. After the addresses have been set, they will be reflected in all the functional objects that reference the symbols.

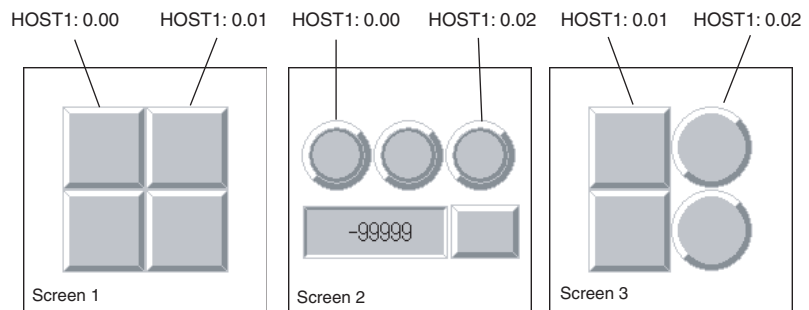

4-2 Using Screens from Other Projects

Screens from different projects can be copied between project workspaces if more than one copy of CX-Designer is running at the same time.

If there is an alarm/event display object, data log graph, or other functional object on the copied screen that accesses common settings, the common settings are automatically copied as well. This means that settings do not need to be adjusted to use the same common settings in both the source and destination project.

Procedure

- 1,2,3...
1. Start two copies of CX-Designer and open the source project on one copy and the destination project on the other copy. Open the project workspace Screen/Sheet Tab Page.
 2. Select the screen to be copied on the source CX-Designer and drag-and-drop the screen to the destination category. The dialog box for setting the destination screen number and host will be opened.

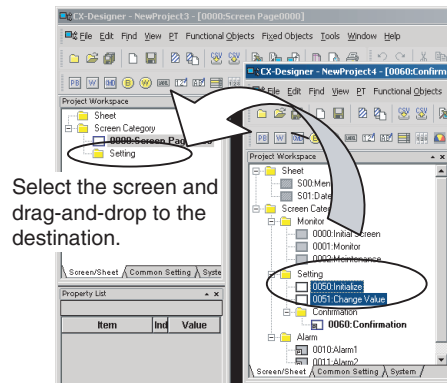

3. Specify the destination screen number and the address host in the dialog box. The screen will be copied.

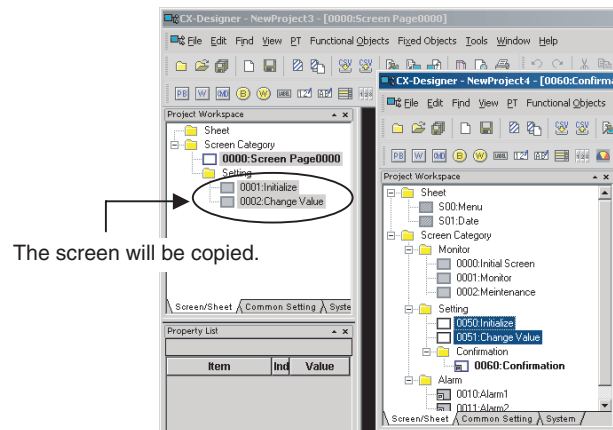

4. The addresses used in the source screen will be automatically copied to the symbol table in the destination project. The common settings accessed by screens are also added automatically.

■ Copying Screens with Alarm/Event Displays

Source settings

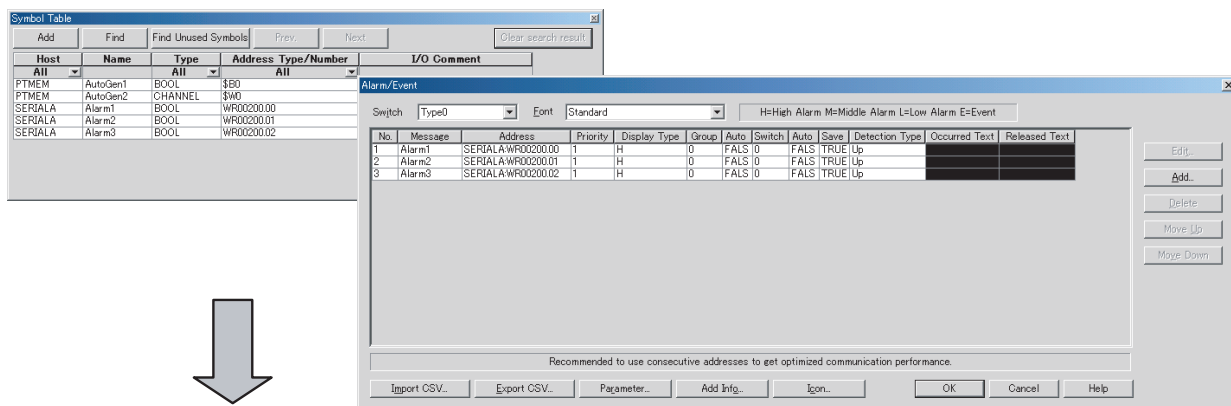

Destination settings

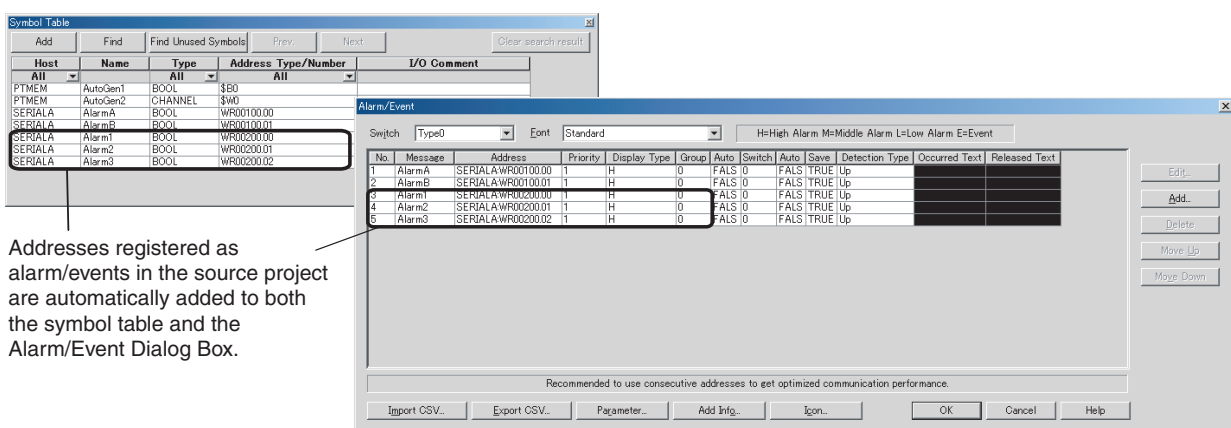

- Address allocations can be changed from the symbol table to an address suitable for the destination project. (Refer to 4-1 Creating Screens Using Symbols.)

Note

- All screens in a category can be copied by selecting the category and dragging-and-dropping it to another project workspace.
- Sheets can also be copied using the same method.
- Common settings can be copied by selecting them on the project workspace Common Settings Tab Page and dragging-and-dropping them to another CX-Designer's project workspace Common Settings Tab Page.

4-3 Classifying Screens by Application

Screens can be classified by application in the CX-Designer. These classifications are called “screen categories.”

To display screens by screen categories, right-click in the Project Workspace and select **Display Screen Category** from the pop-up menu.

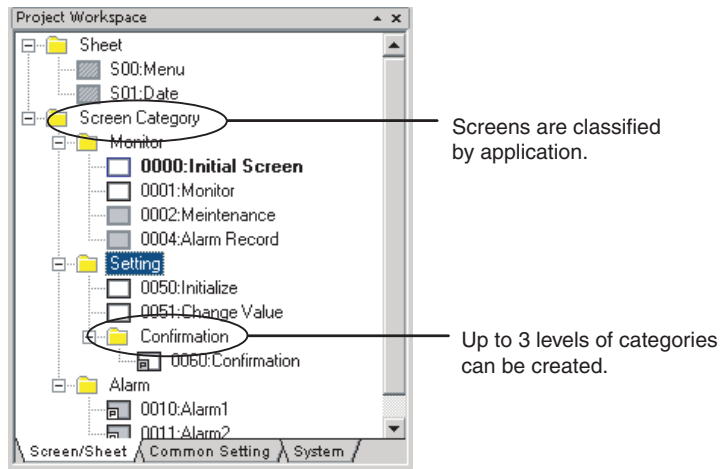

Consecutive screen numbers are automatically allocated in the same category when a new screen is created. The screen numbers can be changed.

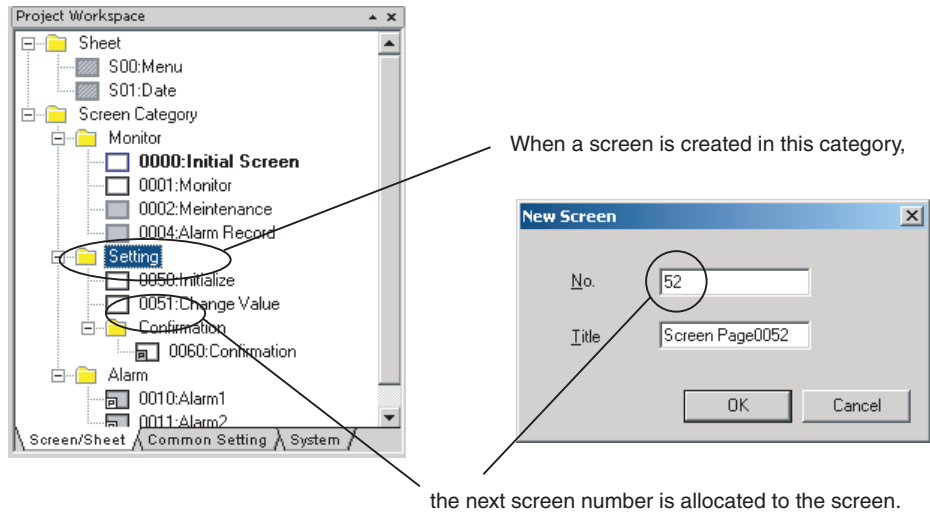

4-3-1 Creating Categories

- 1,2,3...
1. Open the project workspace Screen/Sheet Tab Page.
 2. Select **Screen Category** or an existing category.
 3. Right-click and select **New Category** from the pop-up menu.

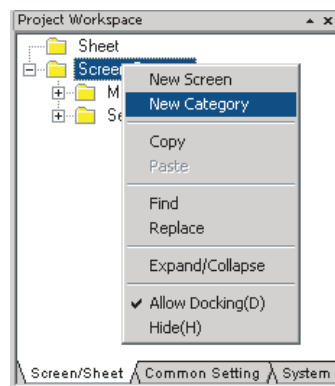

4. A new category will be created. Enter the category name.

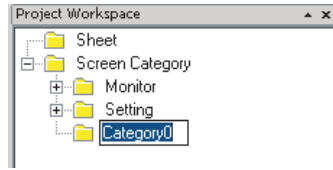

4-3-2 Moving Screens between Categories

Existing screens can be moved to different categories.

- 1,2,3... 1. Select the screen to be moved to a different category from the project workspace Screen/Sheet Tab Page. (More than one screen can be selected.)
2. Drag the screen or screens to the destination category.

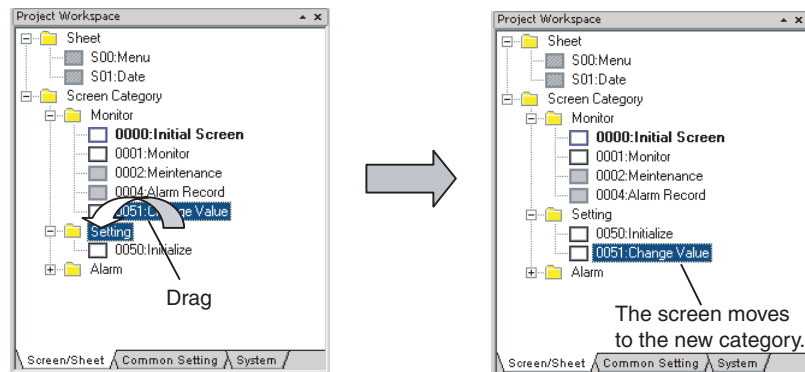

Note Categories can also be moved by selecting and dragging them to the desired location. Screens in that category are also moved.

4-3-3 Creating New Screens

Screens can be created in a category.

- 1,2,3... 1. Select the category for the new screen on the project workspace Screen/Sheet Tab Page.
2. Right-click the screen category and select **New Screen** from the pop-up menu.

4-4 Checking and Changing Functional Object Properties without Opening Property Setting Dialog Boxes

Click a functional object on the screen to display the properties of that object in the Property List. Settings can be checked and changed on the Property List without opening a Property Setting Dialog Box.

Settings for more than one object can be changed in the Property List by using the global replace function.

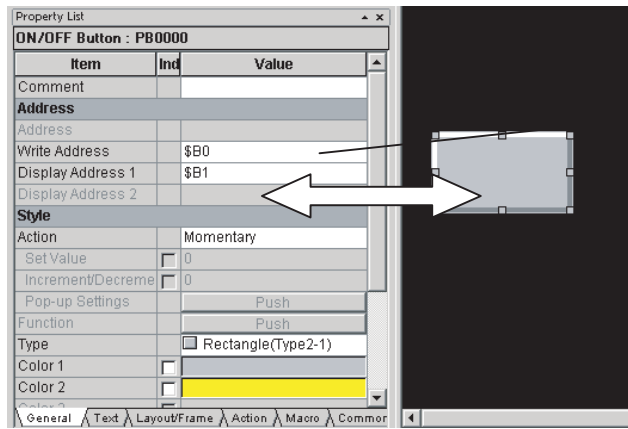

The Property List is used to display and set the properties for the selected object. Changes to properties are immediately reflected on the screen, which enables changes to be checked during screen creation.

Note The Property Settings Dialog Box for an object can still be displayed by double-clicking the object.

4-4-1 Globally Replacing Settings for More Than One Object

More than one item can be selected and settings common to all items can be changed. The changed settings will be reflected in all selected objects.

Procedure

1,2,3...

1. Select all the objects for which settings are to be changed.
2. Change the setting items common to all selected objects on the Property List.

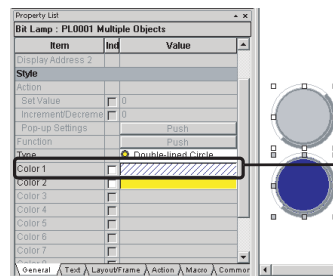

The setting common to the selected objects, **Color 1**, will be changed.

3. The change will be reflected in all objects.

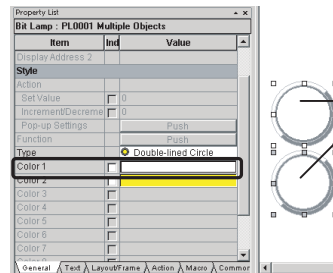

All selected objects change to the same color.

Note Items not common to all selected objects cannot be changed.

4-5 Listing and Editing Functional Object Properties

Properties of objects on the screen can be displayed in table format and the settings changed.

Settings for more than one object can be changed at the same time and consecutive addresses can be automatically set, making editing more efficient.

Procedure

- 1,2,3... 1. Select **Edit - Edit Properties**.
 2. The functional objects on the screen and their properties will be displayed. Entries made to each item will be reflected as changes in the functional object.

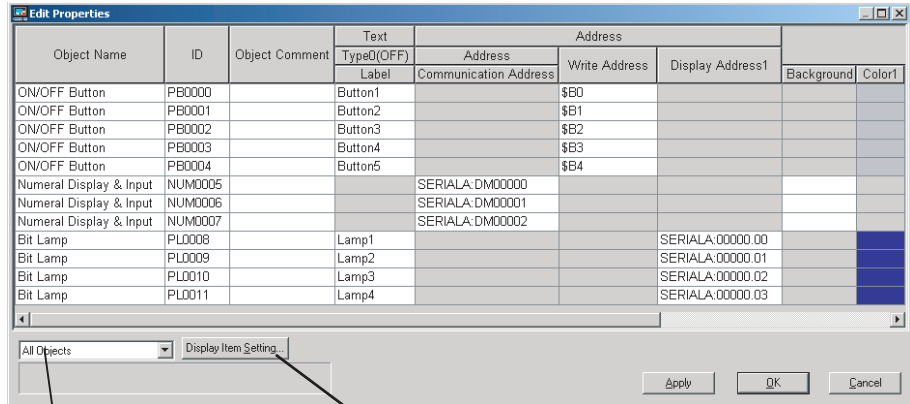

The display can be limited to functional objects selected from the list.

Click the **Display Item Setting** Button to change property settings displayed in the Edit Properties Window.

4-5-1 Setting Consecutive Addresses

Addresses can be changed to make the address consecutive.

- 1,2,3... 1. Select the cell for the set address and move the mouse to the bottom-right of the cell. When the cursor changes to a + cursor, drag the cursor down or up.

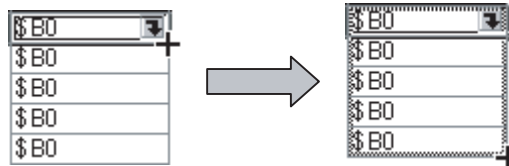

2. The addresses will change to descending order when the cursor is dragged down, and to ascending order when dragged up.

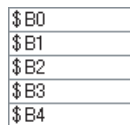

4-5-2 Copying the Same Setting to More Than One Cell

Each setting can be copied to other cells for items of the same type.

- 1,2,3... 1. Select and copy the desired cell.



2. Select the destination cell and paste the copied setting. Copied settings can be pasted to more than one cell, enabling global replacement of settings.



- Note**
- (1) If an object is selected on the screen, only the properties for the selected functional object are listed.
 - (2) The properties of the following functional objects can be set using the list edit function.
 - ON/OFF Buttons
 - Word Buttons
 - Command Buttons
 - Bit Lamps
 - Word Lamps
 - Text
 - Numeral Display & Input
 - String Display & Input
 - Thumbwheel Switches
 - Dates
 - Time
 - Temporary Inputs
 - Consecutive Line Drawing
 - Multifunction

4-6 Editing Overlapping Objects

The CX-Designer has an Object List Function, which lists objects on the screen.

4-6-1 Method for Selecting Specified Objects

Specify objects in the Object List Window to have that object selected. This enables objects hidden under other objects to be selected and for the settings for these objects to be checked and changed on the Property List.

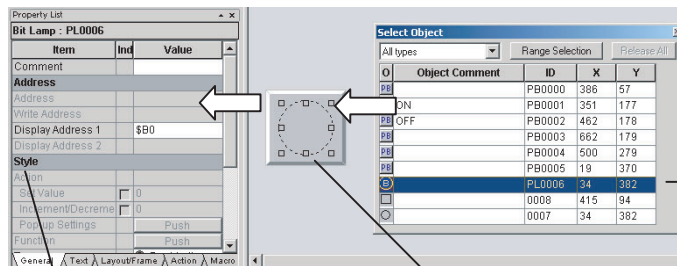

Bit lamp properties can be checked and changed on the Property List.

The bit lamp hidden behind other objects will be selected.

Select a bit lamp in the Object List Window.

Procedure

1,2,3...

1. Select **View - Window - Object List**.
2. The Object List Window will be displayed and the objects on the screen listed.
3. Objects specified on the Object List Window will be selected on the screen. Hold down the **Shift** or **Ctrl** Key to select more than one object. The list of objects in the Object List Window can be restricted to a specific type of object. Select the type of objects to be listed from the drop down list at the top left of the Object List Window.

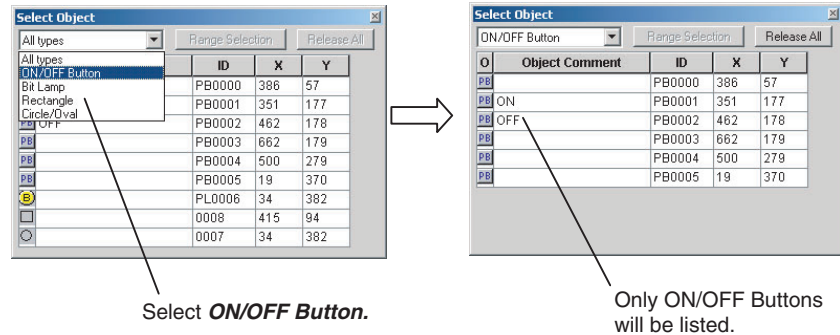

4-6-2 Displaying Only Specified Objects on a Screen

The screen display can also be limited to objects selected on the Object List Window. These objects can be edited on screen.

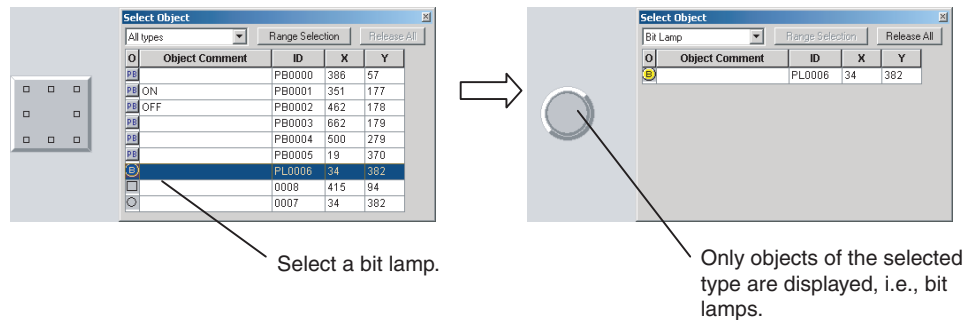

Procedure

1,2,3...

1. Select the object in the Object List Window and click the Range Selection Button.
2. Click the **Release All** Button to display all objects on the screen.

4-7 Creating Multi-language Labels

CX-Designer multi-language displays use Unicode for the character information displayed in a screen. This enables switching the screen between different languages, such as Japanese, English, and Chinese, for display and setting.

The CX-Designer also has functions to export functional object label strings to CSV files and import label strings from CSV files, called the CSV import/export functions.

These functions can be used to edit and set label strings in multiple languages, such as Japanese, English, and Chinese, making it easy to create multi-language screens.

An operating system that supports Unicode is required to use multi-language labels.



Procedure

1,2,3...

1. Select **File - Export to CSV File**.
2. Follow the directions in the displayed dialog box and export the labels to a CSV file. Select *Unicode* in the *Output Code Area*.
3. Edit the CSV file with a version of Excel that supports Unicode (Excel 2000 or higher).

PRJ	Project/Screen No.	Title	Parts ID	Parts Comment	Property	Type0	Type1	Type2
	Screen-0	Screen Page000	PL0003		Caption	異常発生中	Error	异常发生
	Screen-0	Screen Page000	PL0002		Caption	待機中	Waiting	等待中
	Screen-0	Screen Page000	PL0001		Caption	停止	Stop	停止
	Screen-0	Screen Page000	PL0000		Caption	実行中	Runing	运行中

Enter the label strings in Japanese, English, Chinese, etc.

4. Select **File - Import CSV File**.
5. Follow the directions in the displayed dialog box and import the edited CSV file.
The strings in the CSV file will be reflected in each object.

Note

- (1) Set the number of labels to 2 or more under **Project Property** to set multi-language strings for one object.
- (2) In order to create screen data with CX-Designer using the multi-language function, it is necessary to perform Windows settings beforehand. Refer to the CX-Designer online help **Reference - Multi-language Display** for details.

4-8 Checking Address Usage Status

The Address in Use Window displays a list of the number of times each address is used in functional objects.

A list of the functional objects using the addresses is also displayed in the Output Window and specified functional objects can be selected on the screen.

Procedure

1,2,3...

1. Select **View - Window - Address in Use**.

- Set the addresses and search range and click the Go Button to display the number of times the addresses are used.

Displays the addresses.

Sets the start address for the search range.

Sets the search range.

Displays the number of times each address is used. (Unused addresses are displayed in gray.)

	+0	+1	+2	+3	+4	+5	+6	+7	+8	+9	+10	+11	+12	+13	+14	+15
SERIALA:00000.00	6	6	6	6	6	6	6	6	6	6	1	1	1	1	1	0
SERIALA:00001.00	1	1	1	1	1	1	1	1	1	0	0	0	0	0	0	0
SERIALA:00002.00	1	1	1	1	1	1	1	1	1	0	0	0	0	0	0	0
SERIALA:00003.00	1	1	1	1	1	1	1	1	1	1	1	1	1	1	1	1
SERIALA:00004.00	0	0	0	0	0	0	0	0	0	0	0	0	0	0	0	0
SERIALA:00005.00	0	0	0	0	0	0	0	0	0	0	0	0	0	0	0	0
SERIALA:00006.00	0	0	0	0	0	0	0	0	0	0	0	0	0	0	0	0
SERIALA:00007.00	0	0	0	0	0	0	0	0	0	0	0	0	0	0	0	0
SERIALA:00008.00	0	0	0	0	0	0	0	1	1	1	1	0	0	0	0	0
SERIALA:00009.00	5	5	5	5	5	5	5	5	5	5	5	5	5	5	5	5

- Select an address and click the **Find Reference Object** Button to display a list of functional objects using that address in the Output Window. Select a functional object in the Output Window to automatically select that object on the screen.

Page	ID	Host	Name	Address	I/O Comment	Label	Object Com	Detailed Information
0001	NUM0067	SERIALA	Status	00000	Status			Numeral Display & Input : Address
0001	PL0068	SERIALA	Running	00000.00	Running			Bit Lamp : Display Address
0002	PL0000	SERIALA	Running	00000.00	Running			Bit Lamp : Display Address
0002	NUM0001	SERIALA	Status	00000	Status			Numeral Display & Input : Address
0003	NUM0009	SERIALA	Status	00000	Status			Numeral Display & Input : Address
0050	NUM0001	SERIALA	Status	00000	Status			Numeral Display & Input : Address

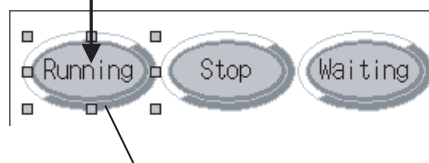

Objects selected in the Output Window are selected on the screen.

Note Searches can be made for the addresses used in a project or in a screen and the results displayed in a list. Select **Find - Address Cross Reference**.

4-9 Searching for Embedded Macros

Embedded macros can be found and displayed in the Output Window.

Objects selected in the Output Window are automatically selected, so macro details can be checked on the Property List.

Procedure

- 1,2,3... 1. Select **Find - Macro Cross Reference**.
2. Specify the search range in the displayed Search Embedded Macro Dialog Box and execute the search.
3. A list of macro locations will be displayed in the Output Window.

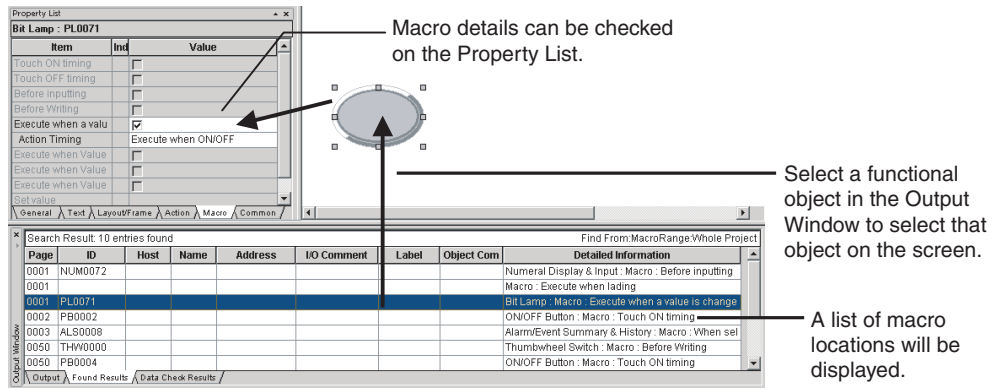

4-10 Transferring Only Edited Data to PT

The data is edited and transferred to the PT many times when debugging projects.

The CX-Designer has a Quick Transfer function. The Quick Transfer function automatically compares project data with the data already transferred to the PT and transfers only changed data.

This means that only the required data is transferred to the PT, which greatly reduces the time and work required for transfers.

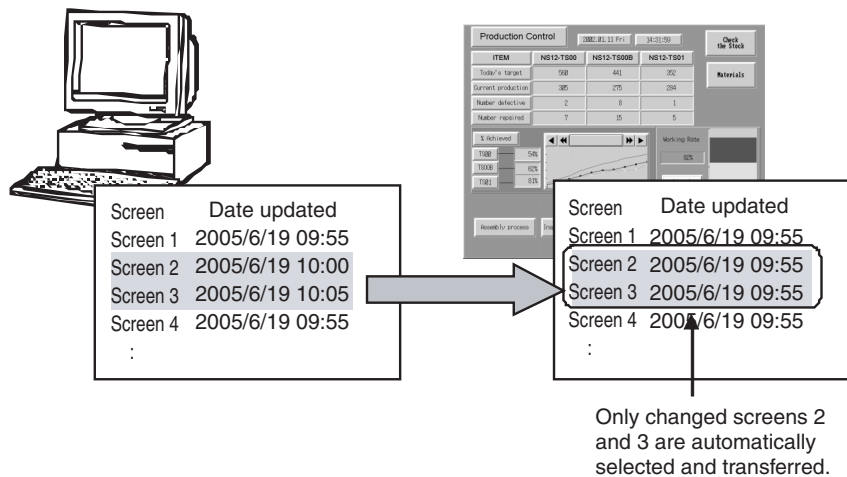

Procedure

- 1,2,3... 1. Select **PT - Transfer - Quick Transfer [Computer → PT]**.
2. A dialog box to confirm the transfer will be displayed. Press the Yes Button to start transferring the data.

Note

- (1) Transfer routes and other settings need to be made before executing Quick Transfer. Select **PT - Transfer - Transfer Setting** to make the settings.
- (2) Select **PT - Transfer - Transfer [Computer → PT]** to transfer data for the whole project to the PT.

4-11 Creating Documents

Project and screen settings and functional object property settings can be output to RTF files by using the CX-Designer print function.

Screen images can also be output to bmp and jpg files.

The CX-Designer print function facilitates the production of a variety of documents, e.g., these files can be used as is for specifications, or the data can be processed to create operation manuals, etc.

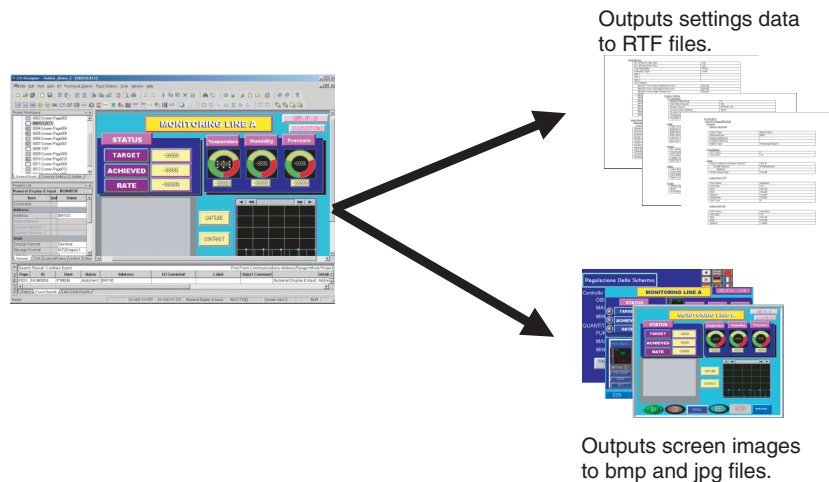

Procedure

- 1,2,3... 1. Select **File - Print**.

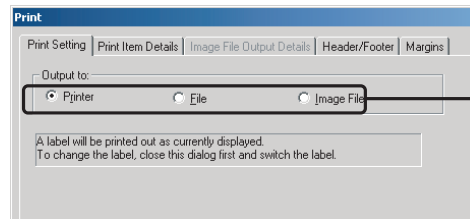

Select **File** to output settings to an RTF file. Select **Image File** to output screen images to a bmp or jpg file.

2. When printing is executed, an RTF or bmp/jpg file is created.

- Note**
- (1) If **Output to:** is set to **Printer**, the settings will be output to the printer.
 - (2) If **Output to:** is set to **File** or **Printer**, header, footer, and margin settings can be made.

4-12 How to Use Help

Press the **F1** Key or click the **Help** Button in dialog boxes to display help information relating to the selected menu or dialog box.

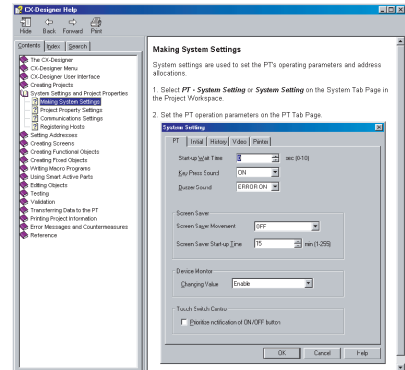
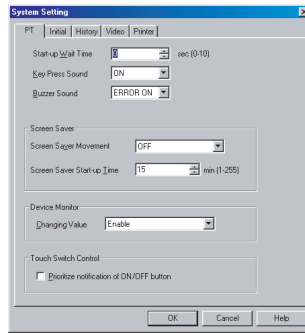

Press the **F1** Key or click the **Help** Button on the History Tab Page of the System Setting Dialog Box.

A description of the History Tab Page of the System Setting Dialog Box will be displayed.

Procedure

Click on the diagram in Help Mode to display a description or switch to another topic.

If the mouse is moved to locations that can be clicked in Help Mode, the cursor will change shape to .

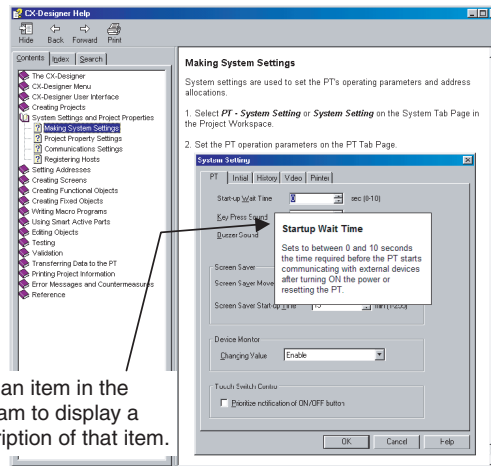

Click an item in the diagram to display a description of that item.

If there is a tab page in the explanatory dialog box, the Help diagram display can be switched by clicking that tab page.

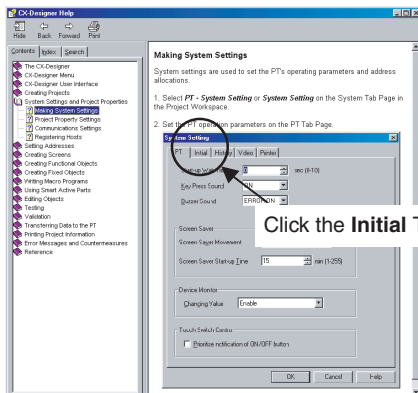

Click the **Initial** Tab Page.

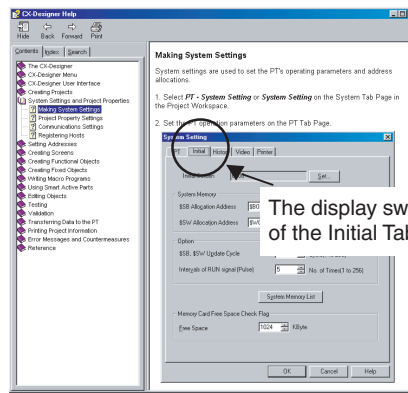

The display switches to a description of the **Initial** Tab Page.

4-13 Integrated Simulation for the Entire System

The CX-Designer can simulate PT operations on a personal computer, so screens created on the computer can be debugged using the test function even without transferring the screens to a PT.

Note The following applications are closely linked together for integrated simulation. If you update any of these applications, update all of them at the same time.

- CX-Designer
- CX-Programmer
- CX-Simulator
- CX-Server
- Sysmac Studio
- Communication Middleware

4-13-1 Debugging Screens and the User Program with a Virtual PLC

The CX-Designer can be connected to virtual PLCs running on the CX-Simulator (i.e., on a user program execution engine). By using the CX-Simulator to run programs created using the CX-Programmer, screen data and user programs can be debugged together on a personal computer.

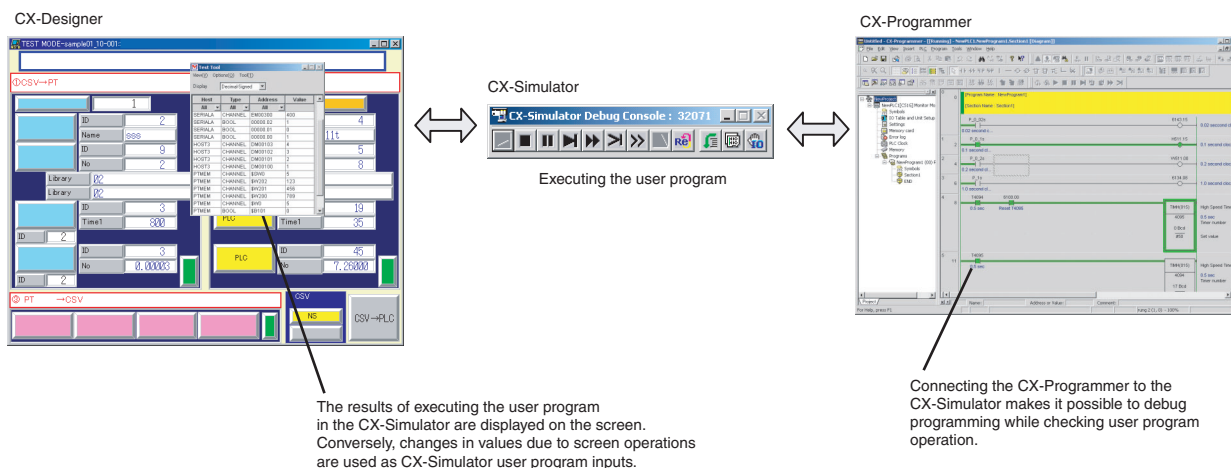

Note If the host is an NJ/NX-series Controller, integrated simulation must be started from the Sysmac Studio. For details, refer to the *Sysmac Studio Version 1 Operation Manual* (Cat. No. W504).

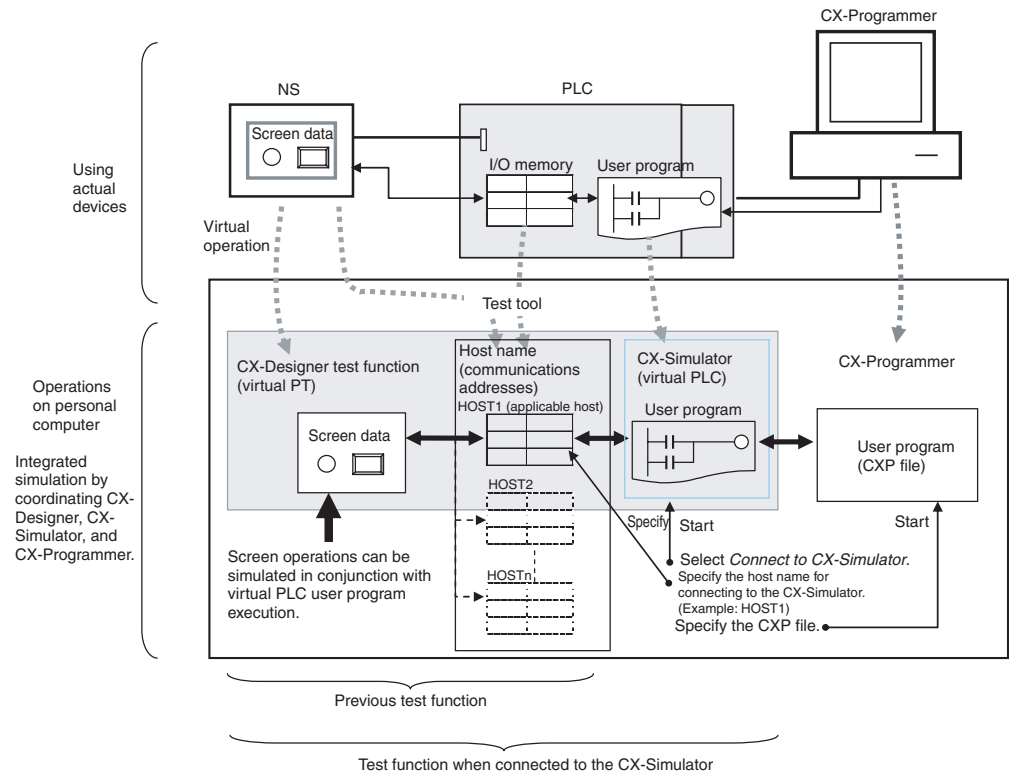

Procedure

- 1,2,3... 1. Click the **PLC-PT Integrated Simulation Button** () in the Tool Bar.
 2. Specify the host name to connect to the CX-Simulator, select the user program (CXP file) to be written, and click the **Start Button**.

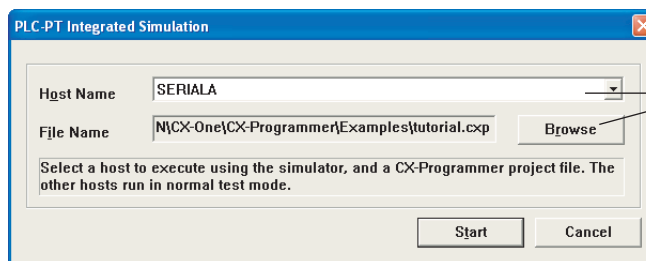

Specify the host name to connect to the CX-Simulator, and specify the user program (i.e., specify the CXP file).

3. The CX-Simulator and the CX-Programmer will start, and the user program will be written to the CX-Simulator.
 4. The CX-Designer test function will start, and the specified host will be connected to CX-Simulator.
 5. When the user program is executed or debugged (step, scan execution, etc.), the applicable host communications addresses are changed according to the user program execution results, and this is reflected in the lamps on the screen and in the numeric displays. Conversely, applicable host communications address values are changed according to screen button operations and numeric inputs, and these are used as inputs for user program execution. This enables the simulation of screen operations in conjunction with virtual PLC user program execution.

Note

- (1) If a test is performed from the CX-Designer while the CX-Simulator is already running, a connection will be made to the CX-Simulator.
 (2) Only one host can be connected to the CX-Simulator. If multiple hosts are set in a CX-Designer project, use the test tool to change the communications address values for the hosts that are not connected to the CX-Simulator.

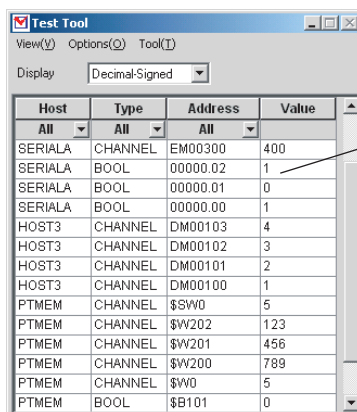

All of the communications address used by the displayed screen are displayed in a list. For example, if host SERIALA is connected to the CX-Simulator, the SERIALA communications addresses are used as values at the CX-Simulator. The values for other host communications addresses can be changed using the test tool.

- (3) Address values at the CX-Simulator can be changed using the Switch Box Utility. The Switch Box Utility can be started from the test tool.
 (4) The CX-Designer will be minimized when the test is started.
 (5) If the **Start test from the current screen** Option is selected under **Tools - Test**, the screen currently being edited will be opened when the test is started. If this option is not selected, the test will start with the initial screen specified in the PT's System Settings.
 (6) Integrated simulation can be executed by selecting **Tools - Test** and then selecting **Connect to CX-Simulator** from the Test Dialog Box.

(7) Equivalent functionality is also provided by integrated simulation with the Sysmac Studio.

4-13-2 Debugging Screens and the User Program with the Actual PLC

With CX-Designer, simulation can be executed with the personal computer connected to an actual PLC. This enables debugging (including monitoring and settings) using actual I/O Units, Special I/O Units, and CPU Bus Units connected to the PLC, as well as data from external devices and PLC data on the network.

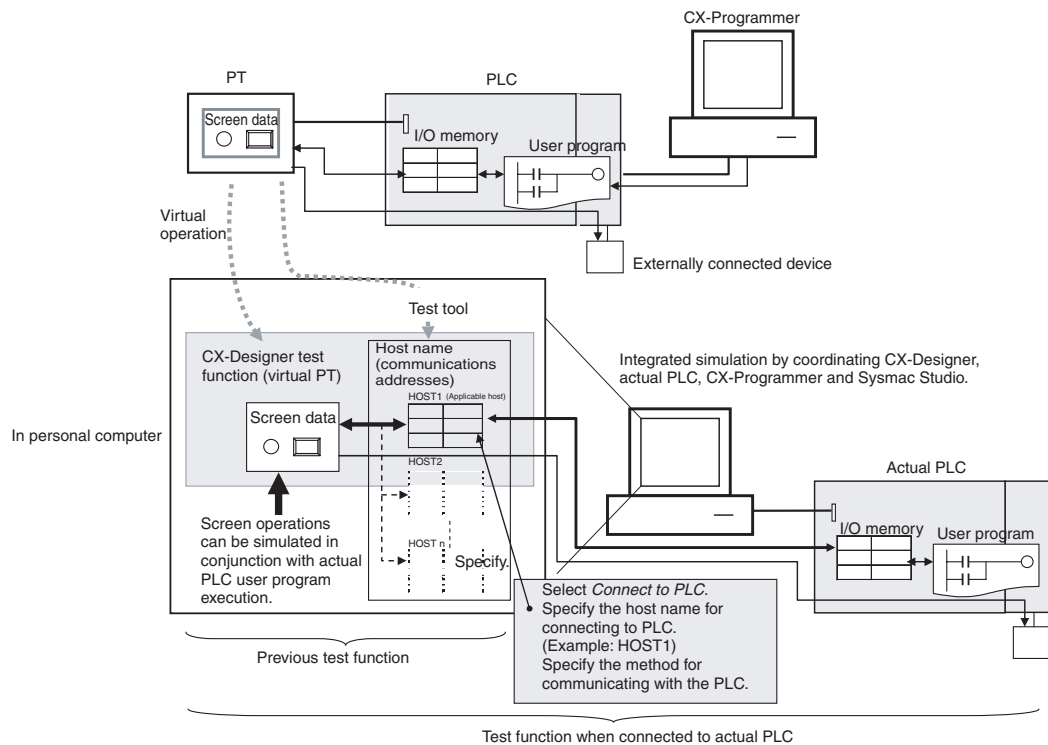
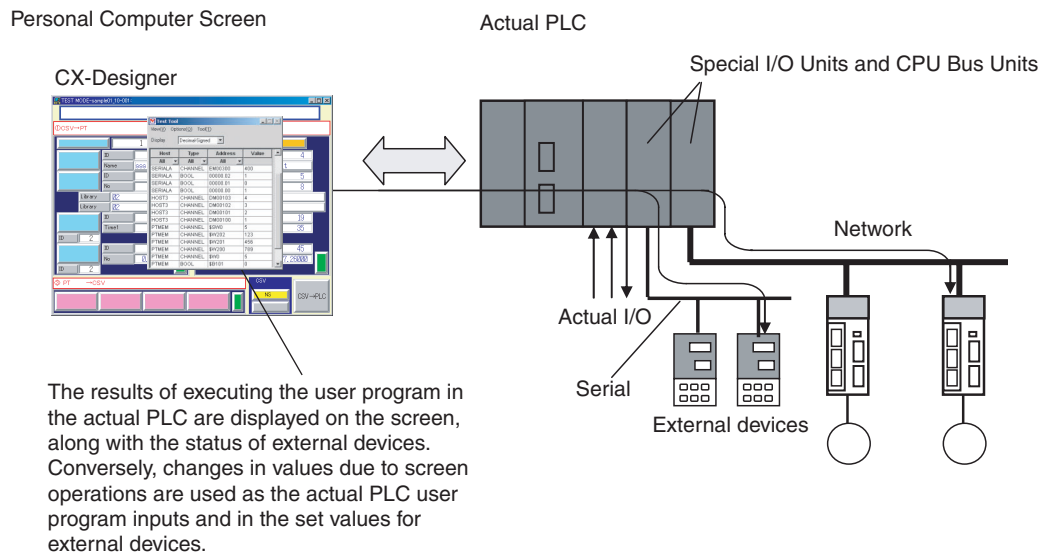

Procedure

- 1,2,3...
1. Connect the personal computer to the PLC by either a serial or network connection.
 2. Select **Tool - Test**.
 3. Select **Connect to PLC**, specify the host name and host type for connecting to the PLC, specify the communications method, and click the **Start** Button.

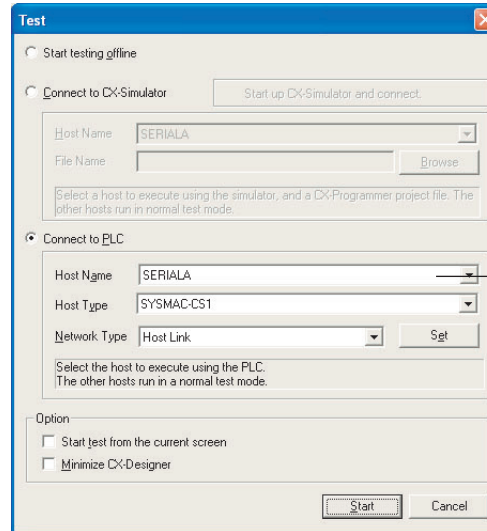

Select **Connect to PLC**, specify the host name and host type for connecting to the PLC, and specify the communications method.

4. The CX-Designer test function will start and the actual PLC will be connected.
5. When the actual PLC user program is executed, the applicable host communications addresses are changed according to the user program execution results, and this is reflected in the lamps on the screen and in the numeric displays. Conversely, applicable host communications address values are changed according to screen button operations and numeric inputs, and these are used as inputs for execution of the actual PLC user program. This enables the simulation of screen operations in conjunction with actual PLC user program execution.

Note Connecting to the actual PLC is not supported when connected to a C-series PLC.

4-14 Setting Security for Data Transfers with the PT

Transfers between the Computer and PT

When a project for which data transfer security has been set is stored in the PT, a password is required to upload the project data from the PT. Data cannot be uploaded from the PT unless the correct password is input, preventing theft of data from the PT. A password is also required in order to download data. This prevents data from being accidentally overwritten.

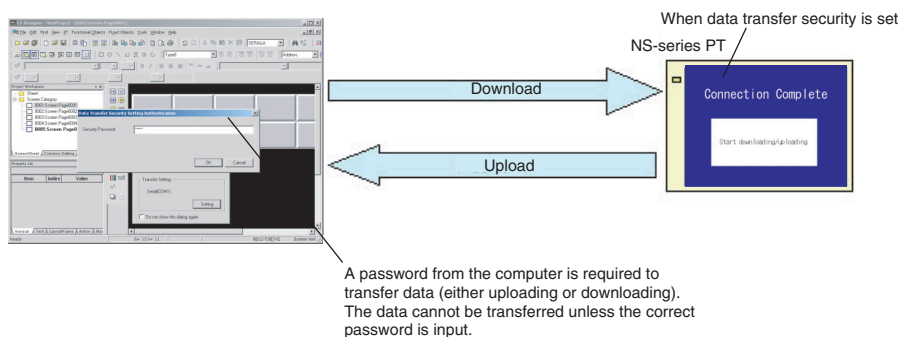

Transfers between the PT and a Memory Card

When a project for which data transfer security has been set is stored in the PT, a password must be input at the PT to upload the project data from the PT to a Memory Card. Data cannot be uploaded from the PT unless the correct password is input, preventing theft of data to a Memory Card. A password is also required to download data from a Memory Card. This prevents data from being accidentally overwritten.

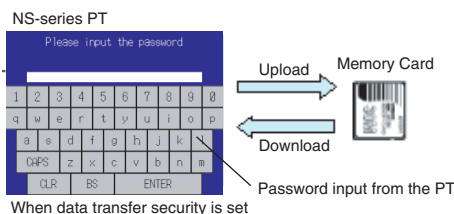

Procedure

- 1,2,3...
1. Select **File - Data Transfer Security - New Data Transfer Security** Setting.
 2. Set the security password.
 3. Transfer to the PT the project for which data transfer security has been set.

4-15 Setting Symbol Names and I/O Comments for Use as Labels

Symbol names or I/O comments of communications addresses can be automatically used as label text strings for the following functional objects.

- ON/OFF Buttons (when Write Address is set)
- Word Buttons (when Write Address is set)
- Bit Buttons (when Display Address is set)
- Word Lamps (when Display Address is set)

In the same way, when setting communications addresses in the Alarm/Event Details Dialog Box, symbol names or I/O comments can be set as the alarm messages.

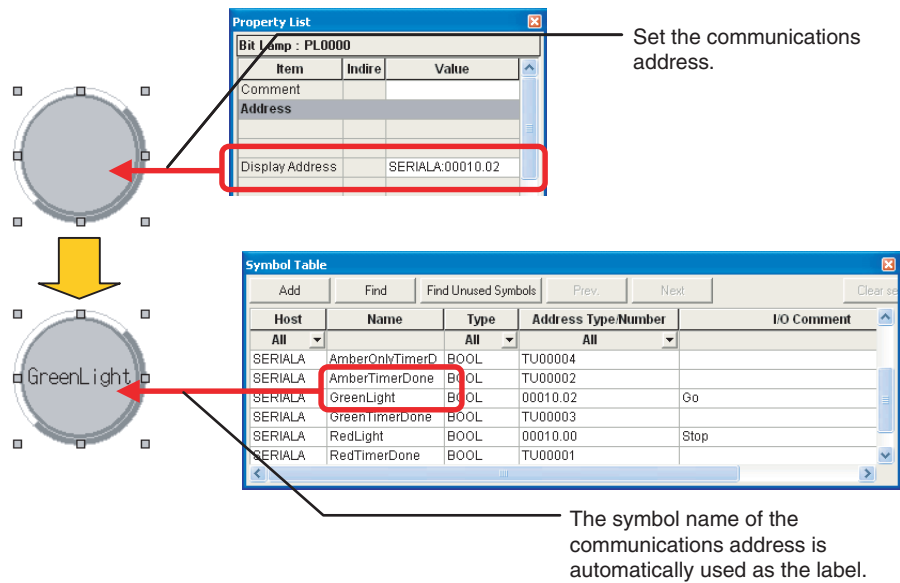

Procedure

1,2,3...

1. Select **Options** from the Tools Menu. The Option Dialog Box will be displayed.
2. Open the **Edit/Display** Tab Page in the Option Dialog Box.
3. Select **Reflect to label when an address is set**, and select either **Symbol Name** or **I/O Comment** for the label text string.

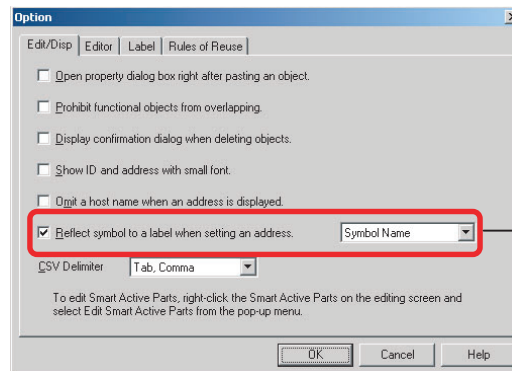

4. Create the functional object.
5. Set the communications address for the functional object in one of the following ways.
 - Input the address in the field in the Property Setting Dialog Box for the functional object.
 - Input the address in the field in the Property List.
 - Use the Address Tool Bar.
 - Edit the properties in table format.

The symbol name or I/O comment that has been set will be automatically set as the label text string.

6. To set an alarm message, select **Alarm/Event Setting** from the PT Menu. The **Alarm/Event** Setting Dialog Box will be displayed.
7. Click the **Add/Edit** Button in the dialog box to open the Alarm/Event Details Tab Page.

8. Set the communications address in the Address Field. The symbol name or I/O comment for the communications address that was set for the message will be used automatically.

- Note**
- (1) If there are two or more labels, the symbol name or I/O comment will be set for the text strings for all of the labels.
 - (2) Symbol names and I/O comments will not be set automatically in the following cases:
 - When the communications address is replaced by another one.
 - When a symbol name or I/O comment is changed in the symbol table after the label text string has been set.
 - When communications address settings other than those indicated above are set.
 - When the communications address is set by a method other than those indicated in step 5.

4-16 Executing Multiple Functions with a Single Operation

With Multifunction Objects, multiple processes can be set and can then be executed with just the press of a button. Processes that could previously be executed only by using macros can now be easily executed by making settings based on properties.

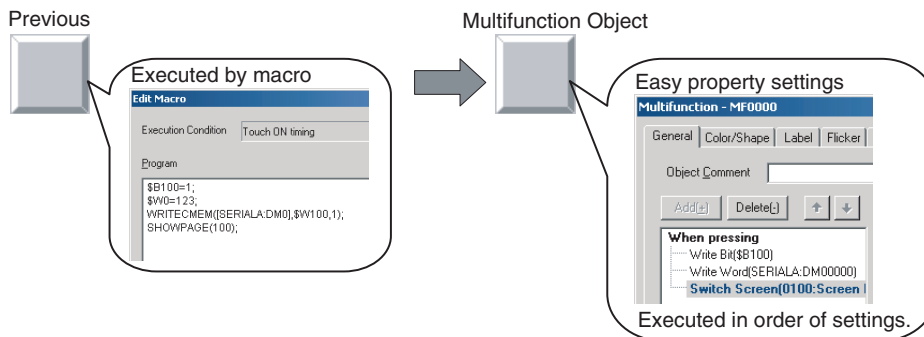

Procedure

This procedure describes how to use a Multifunction Object to perform the following operations.

- Turn ON \$B100.
- Set SERIALA:DM0 to 123.
- Switch to screen 100.

- 1,2,3...**
1. Create a Multifunction Object and open the Property Setting Dialog Box.
 2. In the General Tab Page, open the When pressing Tab Page and select the first item in the action item list.
 3. Click the **Write** Button and select **Write Bit** from the menu. The properties for the bit setting will be displayed.
 4. Set \$B100 for the write address, and SET for the action.

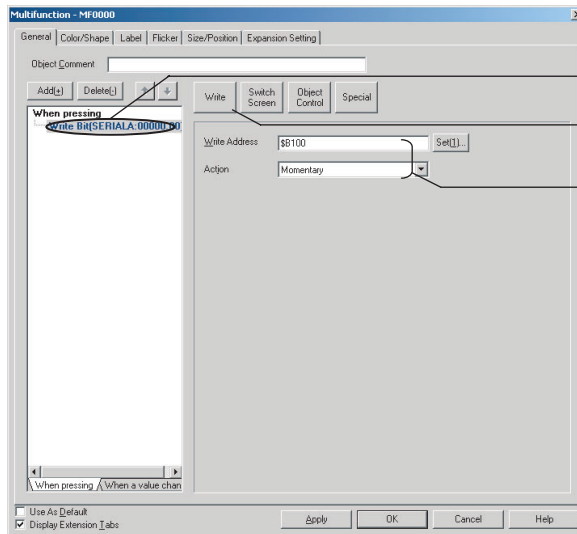

1. Click the first item.
2. Click the Write Button and select Write Bit.
3. Make the following settings:
 - Write Address: \$B100
 - Action: SET

5. Click the **Add** Button to add the new action item.
6. Click the **Write** Button and select **Write Word** from the displayed menu.
7. Set *SERIALA: DM0* for the write address, *Set Value* for the action, and *123* for the set value.

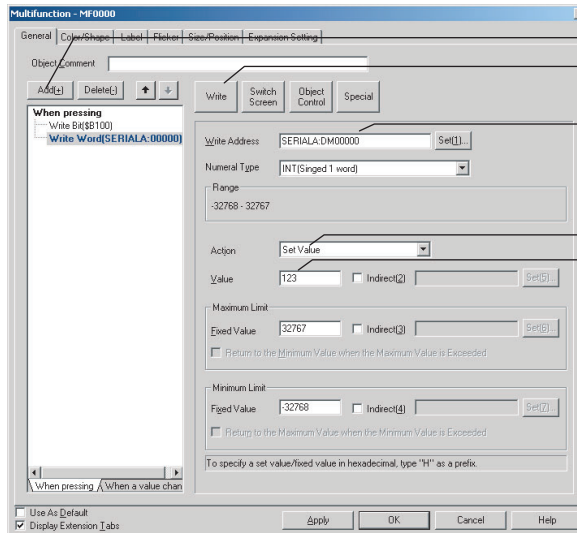

1. Click the **Add** Button.
2. Click the **Write** Button and select **Write Word**.
3. Make the following settings:
 - Write Address: SERIAL A:DM0
 - Action: Set Value
 - Set Value: 123

8. Click the **Add** Button to add the new action item.
9. Click the **Switch Screen** Button and select **Switch Screen** from the displayed menu.
10. Set *Specified Screen* for the switch method, and *0100 Screen* for the screen selection.

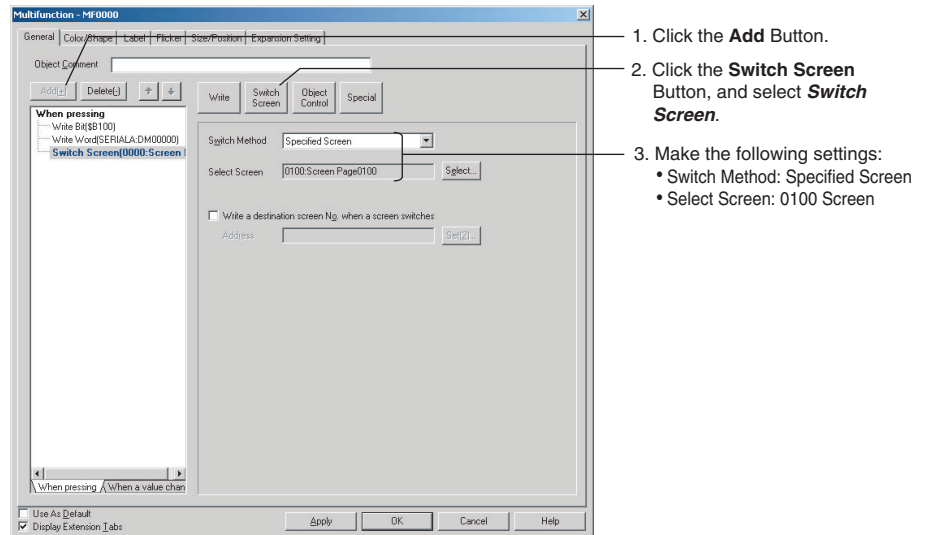

When the Multifunction Object is pressed on the NS-series PT, the functions that have been set will be executed in order.

4-17 Replacing a Lamp with a Button

If a bit lamp is converted to a Multifunction Object, the functions of a button and other functions can be added by simply changing property settings without creating new objects.

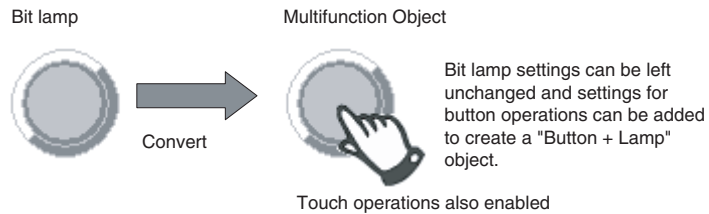

Similarly, converting to a Multifunction Object makes it easy to add new functions to buttons and lamps that have already been created.

Procedure

- 1,2,3...
1. Open the Bit Lamp Property Setting Dialog Box.
 2. Click the **Convert** Button to convert the bit lamp to a Multifunction Object.

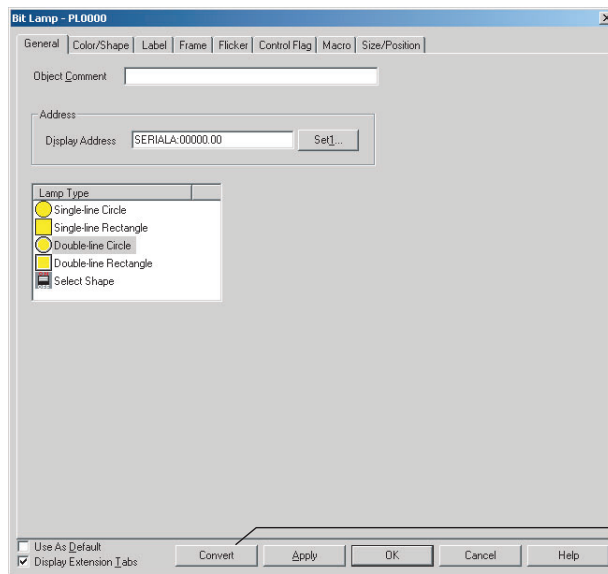

Click the Convert Button.

3. The property settings for the Multifunction Object will open automatically. In the General Tab Page specify *Perform an action when pressing the object* option to set the function for when the Multifunction Object is pressed.

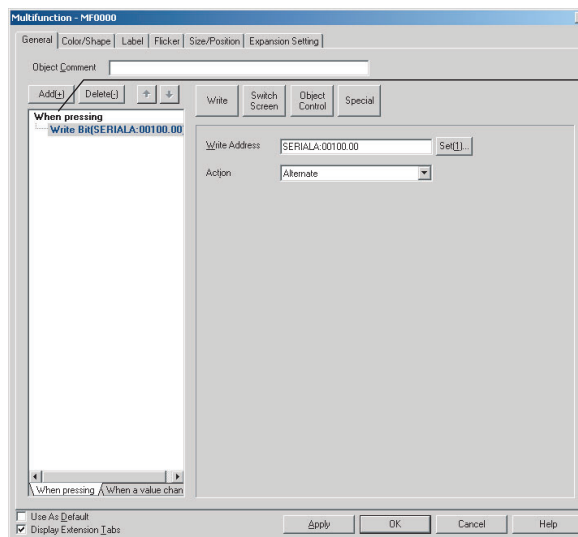

Set the operation for when the Multifunction Object is pressed.

In the Color/Shape Tab Page, the same settings will be set as for the original bit lamp.

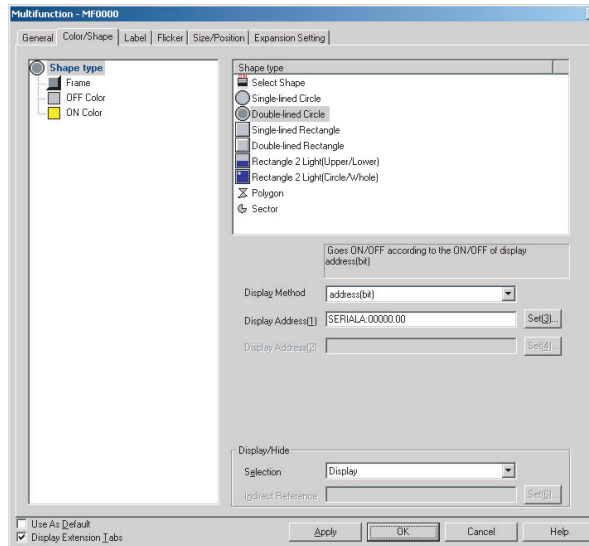

The settings will be the same for the Multifunction Object as for the bit lamp before the conversion.

Note The following functional objects can be converted to Multifunction Objects: ON/OFF buttons, word buttons, command buttons, bit lamps, and word lamps.

4-18 Creating Polygonal Lamps

Polygonal lamps can be created by using Multifunction Objects. This example procedure shows how to create a polygonal lamp that is turned ON and OFF by turning ON and OFF HOST1:0.0.

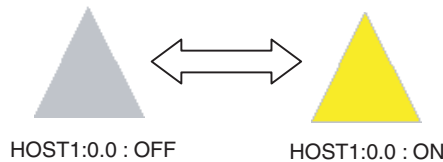

Procedure

- 1,2,3...** 1. Create a Multifunction Object and open the Property Setting Dialog Box. The General Tab Page will be displayed.

- Open the When pressing Tab Page in the action item list. Clear the selection of the *Perform an action when pressing the object* option.

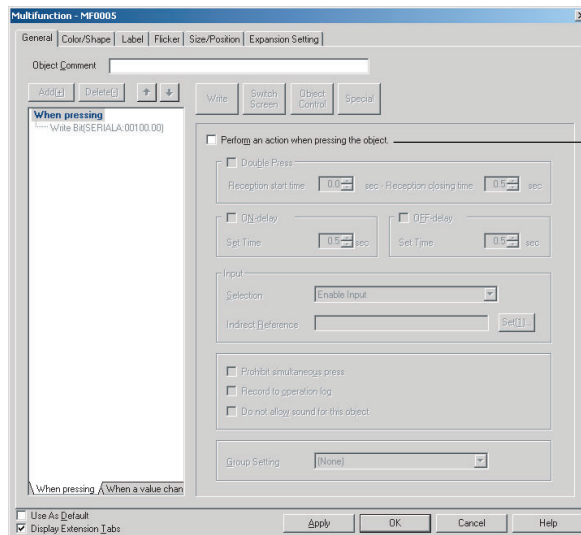

Clear the *Perform an action when pressing the object* option.

- Open the Color/Shape Tab Page and select *Polygon* as the shape. Set *Bit Address* as the display method, and *HOST1:0.0* as Display Address 1.

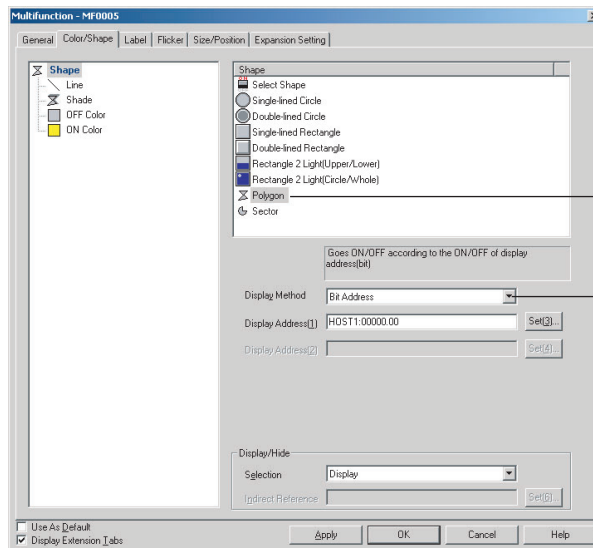

Select *Polygon*.

Select *Bit Address* and *HOST1:0.0*.

- Click the **OK** Button to close the Property Setting Dialog Box. The shape of the Multifunction Object will change to a polygon. The object will be displayed as a pentagon.

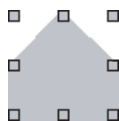

The shape is changed to a pentagon.

5. Change the shape of the Multifunction Object to a triangle by deleting the two unnecessary nodes.



With the Multifunction Object selected, select **Edit Node** from the Edit Menu. Hold down the **Ctrl** Key, move the cursor to the node that is to be deleted, and click the mouse button when the shape of the cursor changes to an X. The node will be deleted.

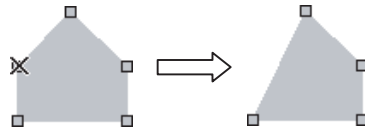

In the same way, delete the other node to change the shape to a triangle.



- Note**
- (1) When using **Edit Node** from the Edit Menu, nodes can be dragged to change their positions. It is also possible to add nodes by clicking on the outline while holding down the **Ctrl** Key.
 - (2) When a Multifunction Object set as a polygon is registered as the default shape, then when subsequent Multifunction Objects are created it will be possible to specify the positions of their nodes just as when creating a polygon.
 - (3) Sector lamps can be created in the same way. For a sector lamp, just select *Sector* as the shape in the Property Setting Dialog Box for the Multifunction Object.

4-19 Registering Contents

Character strings and image files displayed using Machine Navigator are called “contents.” Machine Navigator changes values for specified communications addresses and the displays of contents registered on the screen according to alarms and events that occur. This section describes how to easily register contents.

- 1,2,3...** 1. Create the required number of contents displays on the screen.

- In the General Tab Page in the contents display Property Setting Dialog Box, specify whether character strings or images are to be displayed.

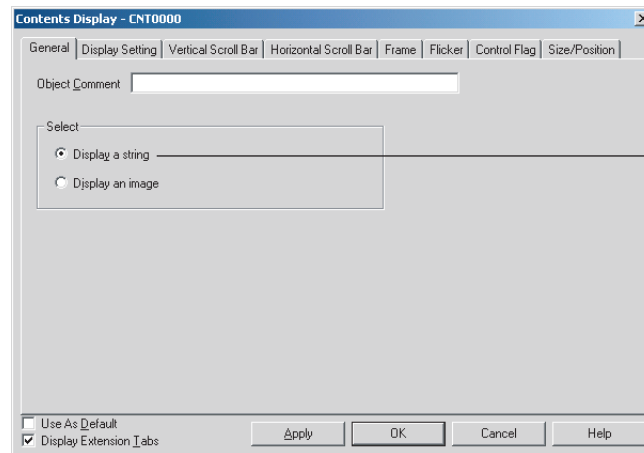

Specify whether character strings or images are to be displayed.

- Set the number of contents in the Edit Contents Toolbar. In the *No. of contents* field, set the total number of character strings and images to be displayed. In the *Address for switching contents*, set the communications address for switching the contents.

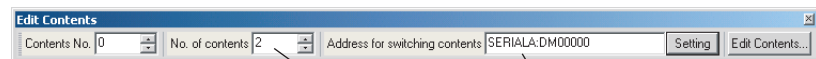

Set the communications address to use to switch contents.
Set the total number of contents to be displayed.

- In the *Contents No.* field in the Edit Contents Toolbar, input the number of the contents to be edited.

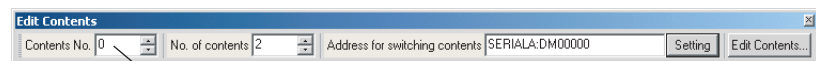

Set the number of the contents to be edited.

- Select the contents display and press the **Space Key**.
If it is a character string that is to be displayed, input the character string.
If it is an image that is to be displayed, the File Selection Dialog Box will be displayed. Select the image file to be displayed.

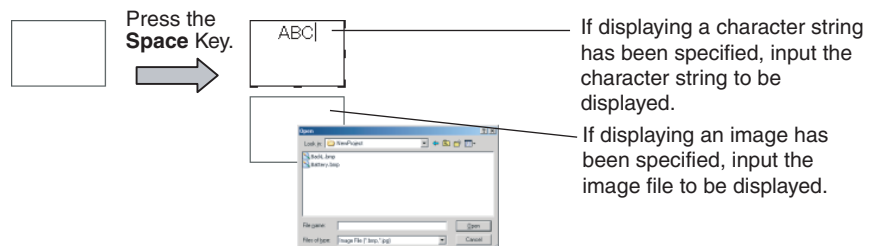

- Repeat steps 4 and 5 as required for the number of contents being created.

Note Make detailed settings for the contents in the Edit Contents Dialog Box that is displayed when the **Edit Contents** Button is pressed in the **Edit Contents** Toolbar.

4-20 Using Machine Navigator

The countermeasures for when an alarm occurs can be automatically displayed using the Machine Navigator function.

The Machine Navigator function changes the character-string and image displays registered on the screen when the value of a specified communications address changes or an alarm or event occurs.

NS-series PT

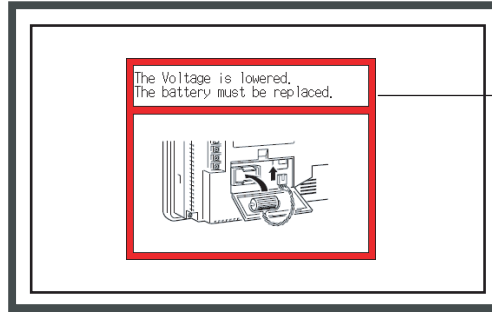

When an alarm occurs, a popup window is automatically displayed to show the countermeasure. It includes both text and graphics.

This section describes how to create the following screen data.

- Registering HOST1:100.00, HOST1:100.01 as an alarm
- Displaying popup window 100 when an alarm occurs
- Displaying the countermeasure for the alarm on popup window 100, and not displaying anything when no alarm occurs

Creating the Popup Window

1. Create popup window 100.
2. Set up two contents displays in popup window 100: one for text and one for images. In the General Tab Page in the Contents Display Property Setting Dialog Box, set *Display a string* and *Display an image*.

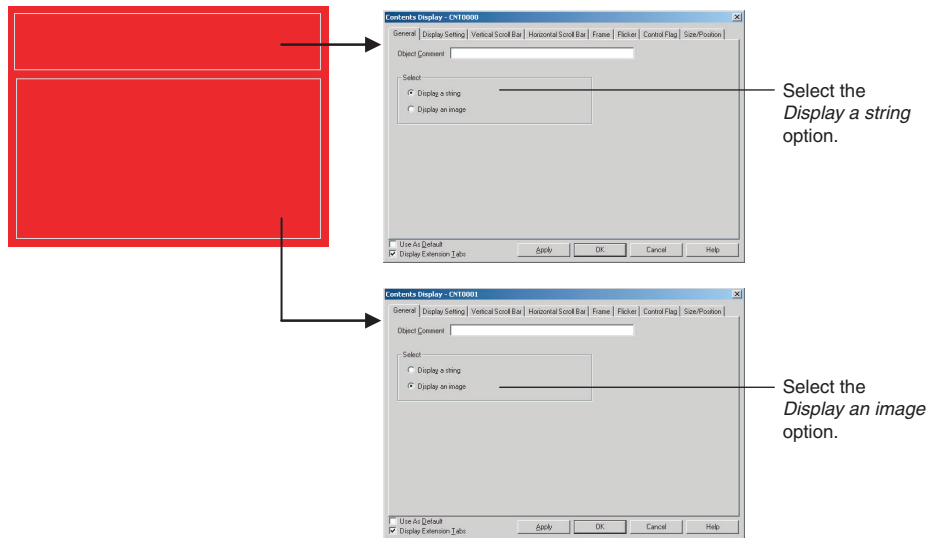

3. Click the **Edit Contents** Button in the Edit Contents Toolbar.



4. The Edit Contents Dialog Box will be displayed. Make the settings for switching contents. (If the settings shown in the figure on the next page are not displayed, click the dialog box title displayed at the upper left of the dialog box.)

- Set *No. of contents* to 3. (The 3 represents two states in which an alarm occurs and one state in which no alarm occurs.)
- Select *Switch contents linking with alarm*. (Default: Selected)
- Set *Contents No. when alarm does not occur* to 0.
- Set *Address for switching contents* to \$W100.

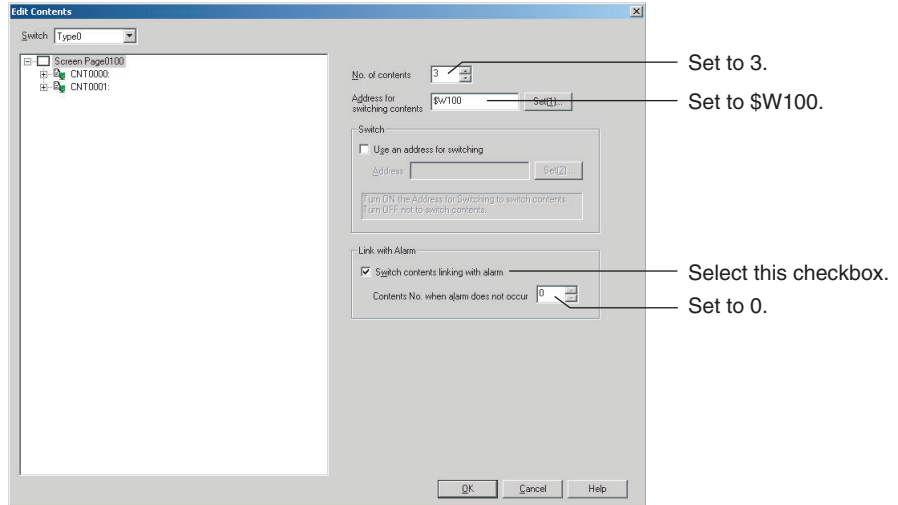

If the contents number is not displayed in the tree on the left of the dialog box, click **+** after inputting the set values.

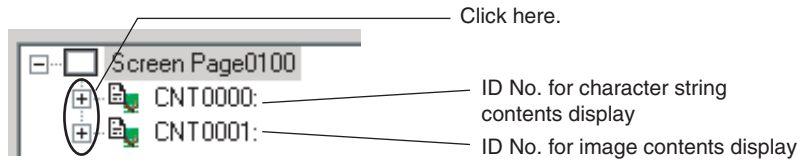

5. Set the contents. (No setting needs to be made for 0 because for *Contents No. when alarm does not occur* is set.)
 - a. Click contents No. 1 for CNT0000 to input the character string for the countermeasure.
 - b. Set the background color to white.

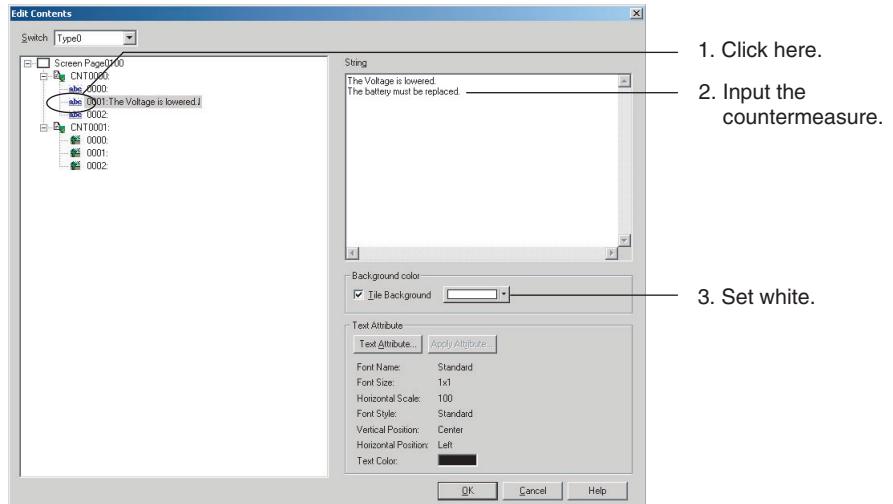

- c. Click contents No. 1 for CNT0001 to set the image file for which the countermeasure is shown.
- d. Set the background color to white.

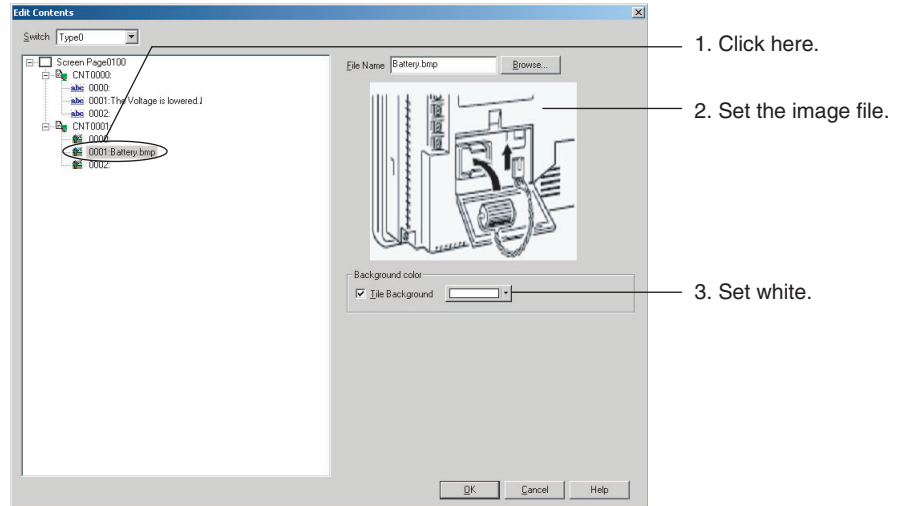

- e. Make the settings in the same way for contents No. 2.

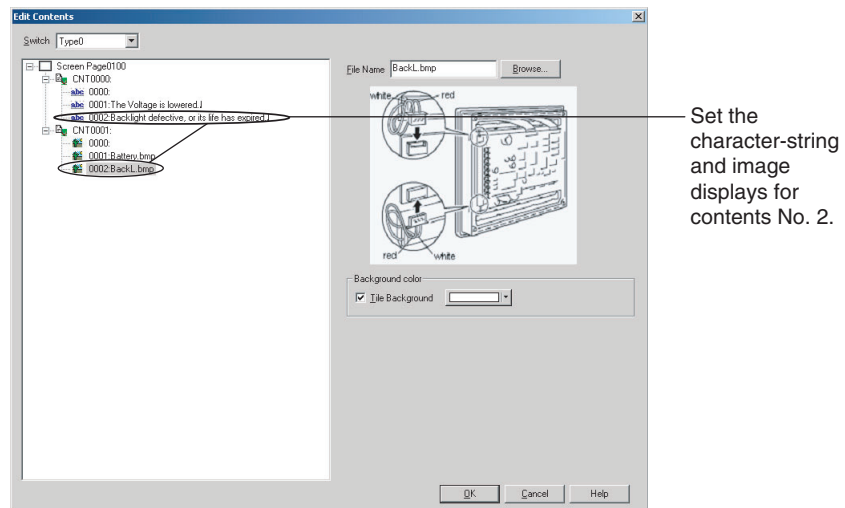

- f. Click the **OK** Button to close the Edit Contents Dialog Box.
6. Make the alarm-related settings.
- a. First select **Alarm/Event Setting** from the PT Menu. The Alarm/Event Setting Dialog Box will be displayed.
 - b. Click the **Add** Button in the dialog box to open the Alarm/Event Details Dialog Box.

The screenshot shows the 'Alarm/Event Details' dialog box with the following settings and annotations:

- Switch:** Type0
- Occurred Text:** (empty)
- Released Text:** (empty)
- Message:**
 - Use the String Table
 - Message:** Battery Error
 - String No.:** (None)
- Address:**
 - Address:** SERIALA:00100.00 (Annotation: 1. Set HOST1:100.00.)
 - Detection Type:** Raise alarm on Set (to 1) of address
- Priority:** 1
- Display Type:** High Alarm
- Group:** 0
- Switch Screen:**
 - Screen Switch:** 100.Troubleshooter (Annotation: 2. Set screen 100.)
 - Switch screen when Alarm/Event occurred (Annotation: 3. Select this checkbox.)
- Switch Contents:**
 - Contents No.:** 1 (Annotation: 4. Set to 1.)
 - Switch contents when Alarm/Event occurred (Annotation: 5. Select this checkbox.)
- Save to History (Total No. of Hist. Settings: 1)
- Delete when Alarm/Event is cancelled
- Display the document on a document display object (Document No.: 1)

- c. Click the **OK** Button to close the Alarm/Event Details Dialog Box.
- d. Make the settings related to HOST1:100.01 in the same way, but in this case set *Contents No.* to 2.

The screenshot shows the 'Alarm/Event Details' dialog box with the following settings and annotations:

- Switch:** Type0
- Occurred Text:** (empty)
- Released Text:** (empty)
- Message:**
 - Use the String Table
 - Message:** Backlight Error
 - String No.:** (None)
- Address:**
 - Address:** SERIALA:00100.01 (Annotation: 1. Set HOST1:100.01.)
 - Detection Type:** Raise alarm on Set (to 1) of address
- Priority:** 1
- Display Type:** High Alarm
- Group:** 0
- Switch Screen:**
 - Screen Switch:** 100.Troubleshooter (Annotation: 2. Set screen 100.)
 - Switch screen when Alarm/Event occurred (Annotation: 3. Select this checkbox.)
- Switch Contents:**
 - Contents No.:** 2 (Annotation: 4. Set to 2.)
 - Switch contents when Alarm/Event occurred (Annotation: 5. Select this checkbox.)
- Save to History (Total No. of Hist. Settings: 2)
- Delete when Alarm/Event is cancelled
- Display the document on a document display object (Document No.: 1)

- e. Click the **OK** Button to close the Alarm/Event Details Dialog Box.
- f. Click the **OK** Button to close the Alarm/Event Setting Dialog Box.
7. The settings are now complete. Transfer the project data to the NS-series PT.

Using the Machine Navigator function, popup screen 100 will be displayed when HOST1:100.00 turns ON at the PT, and the contents of contents No. 1 will be displayed.

Similarly, popup screen 100 will be displayed when HOST1:100.01 turns ON at the PT, and the contents of contents No. 2 will be displayed.

NS-series PT

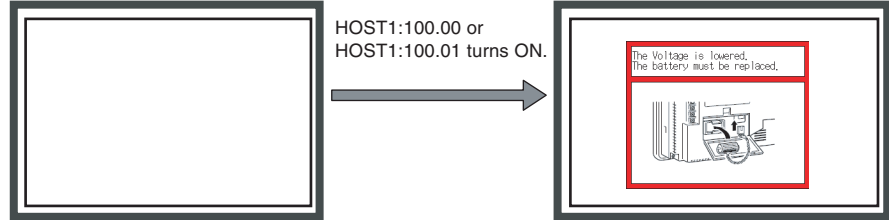

Popup screen 100 is automatically displayed, and contents related to the alarm are displayed in the contents display.

Note Character strings and image files can be set by selecting the contents display and pressing the **Space Key**.

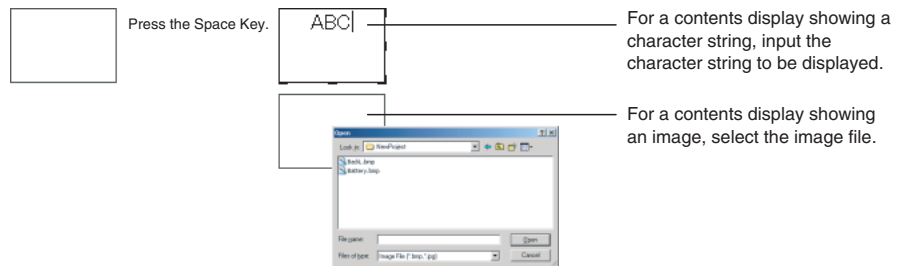

In addition, specifying a contents number in the Edit Contents Toolbar will cause the contents for that number to be displayed. This makes it possible to set character strings and image files for individual contents numbers without having to open the Edit Contents Dialog Box.

The Edit Contents Dialog Box can also be displayed by selecting **PT - Edit Contents**.

4-21 Enlarging Objects Proportional to Screen Size during Data Conversion

Screen objects are now enlarged automatically proportional to the screen size when project data from a low-resolution PT is converted to project data for a high-resolution PT.

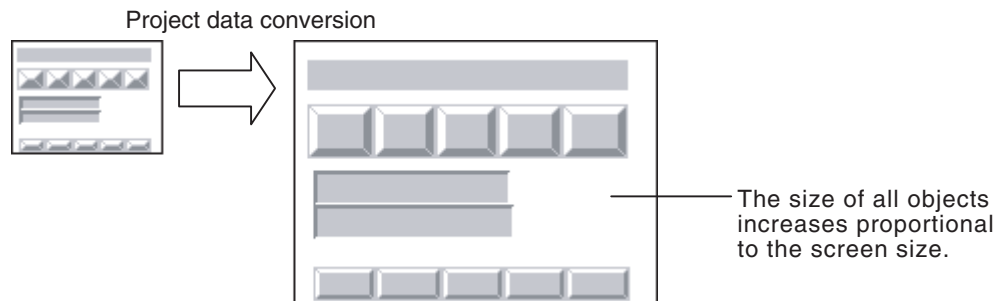

- 1,2,3...** 1. Select **Convert** from the **Tools Menu**.

2. In the Project Data Conversion Dialog Box that is displayed, select the type of conversion and select the check box for screen enlargement.

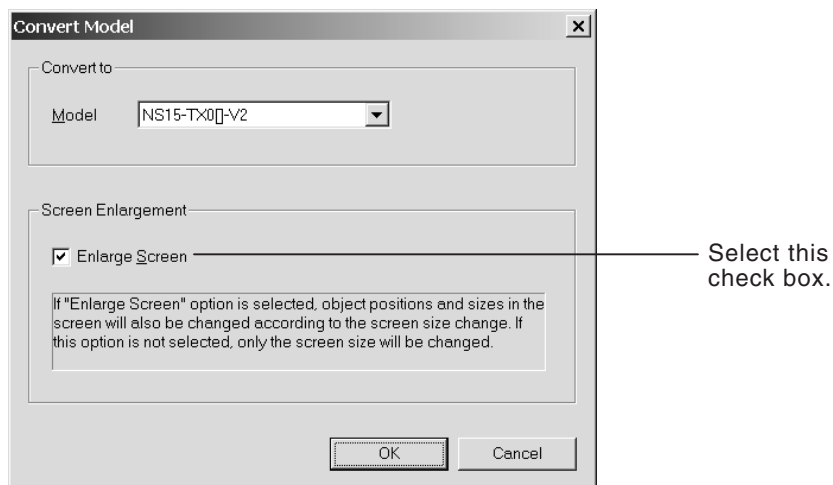

3. Click the **OK** Button.
4. Enter a name for the converted project data.

- Note**
- (1) If the check box for screen enlargement is not selected, only the size of the screen will be enlarged and the objects will remain as they were prior to conversion.
 - (2) The size of objects will not decrease when data for a high-resolution PT is converted to data for a low-resolution PT.

4-22 Batch-setting Label Formats

Display formats for date objects, communications addresses for String Display & Input objects, and other format settings that were previous set individually for each label can now be set as a batch for all labels for the same object.

This allows you to set the format for all labels for one object by performing the format setting procedure only once.

Items That Can Be Batch-set

The objects and items that can be batch-set are listed in the following table.

Object	Items that can be batch-set
String Display and Input	Address information (General Tab Page in the String Display and Input object properties)
List Selection	List data (General Tab Page in the List Selection object properties)
Alarm/Event Display	Date display format (General Tab Page in the Alarm/Event Display object properties)
Alarm/Event Summary & History	Date display format (General Tab Page in the Alarm/Event Summary & History object properties)
Date	Display format (General Tab Page in the Date object properties)
Time	Display format (General Tab Page in the Time object properties)
Data Log Graph	Date and time display format (Time Axis Tab Page in the Data Log Graph object properties)

Settings in the Option Dialog Box

The Option Dialog Box will be displayed when **Options** is selected from the Tools Menu. The following check boxes can be selected on the Edit/Disp Tab Page to batch-set the specified items instead of setting them individually.

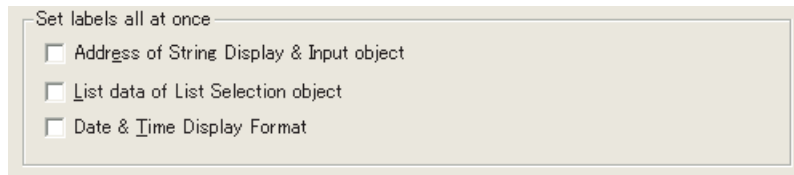

■ Address of String Display & Input object

This option enables batch-setting address information instead of setting it for each label.

■ List data of List Selection object

This option enables batch-setting list information instead of setting it for each label.

■ Data & Time Display Format

This option enables batch-setting the display and time format instead of setting it for each label.

- Note**
- (1) Batch-setting is implemented by clicking the Apply to All Labels Button on the General Tab Page of the Properties Dialog Box for applicable objects.
 - (2) The settings cannot be unified simply by selecting a check box after settings have been made for individual labels. The previous settings will not be changed. To change the previous settings, select the check box and then set the item for which batch-setting is possible.

Setting Example: Batch-setting the Display Format of All Labels for Date Objects.

In this example, there are three labels: Japanese, English, and Chinese

- 1,2,3... 1. Select the *Data & Time Display Format* Check Box on the Options Dialog Box.

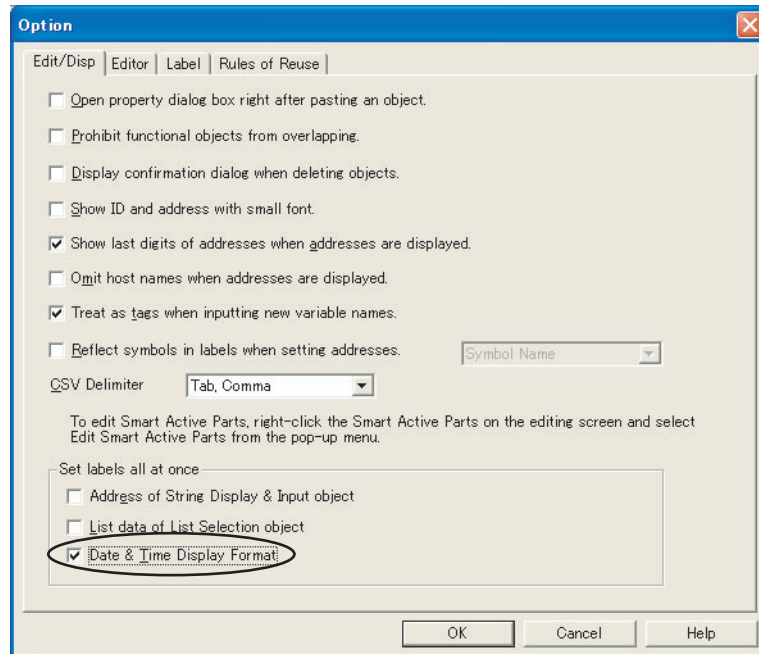

2. Position a date object. The display format will be yyyy/mm/dd/dddd and the same display format will be used for all other labels.

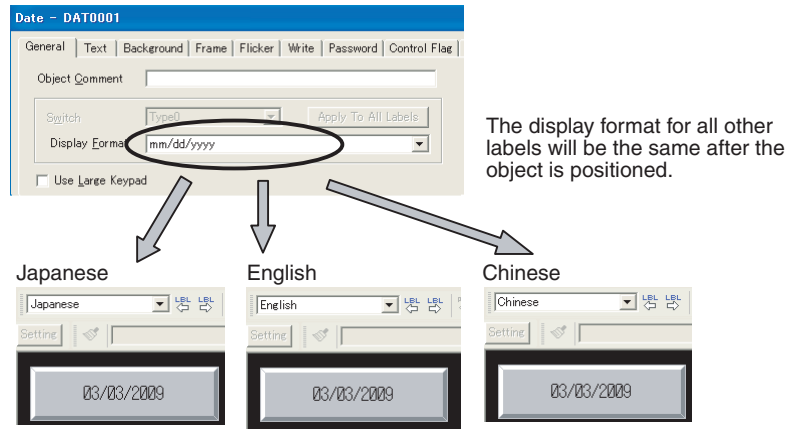

- 3. The display format of the Japanese label is changed to DDD/mm/dd/yyyy. The display format for the other labels will change to the same format.

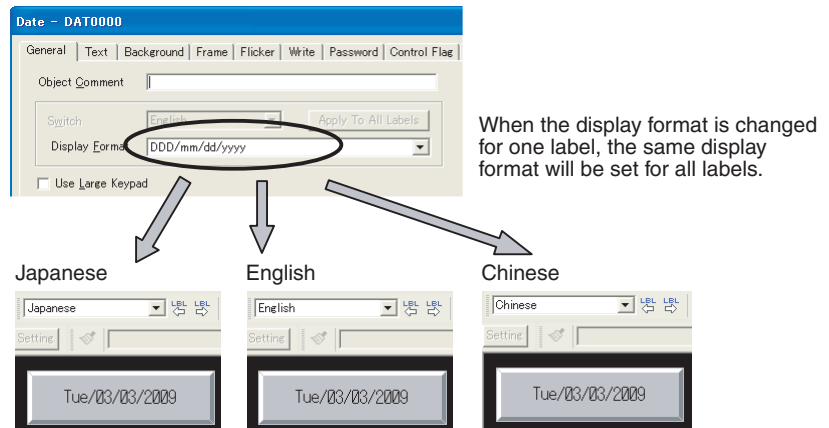

Appendix A

Comparison of Functions with NS-Designer

The following tables show the CX-Designer menus, commands, and functions that correspond to NS-Designer menus.

Menu	NS-Designer menu command	CX-Designer menu/function
File	New Project	File - New Project
	Open Project	File - Open Project
	Save Project	File - Save Project
	Save Project As	File - Save Project As
	Template	---
	Project Maintenance	---
	New Screen	File - New Screen
	Open Screen	File - Open Screen
	Close Screen	---
	Save Screen	File - Save Screen/Sheet
	Save All	File - Save All
	Open Sheet	Project Workspace - Screen/Sheet Tab Page
	Apply Sheet	File - Apply Sheet
	Import CSV File	File - Import CSV File
	Export CSV File	File - Export CSV File
	Transfer Data	PT - Transfer
	Print	File - Print
	Recent Projects	File - Recent Projects
	Exit	File - Exit
Edit	Undo	Edit - Undo
	Redo	Edit - Redo
	Cut	Edit - Cut
	Copy	Edit - Copy
	Paste	Edit - Paste
	Offset Paste	Edit - Repeat
	Delete	Edit - Delete
	Find	Edit - Find
	Replace	Edit - Replace
	Select All	Edit - Select All
	Repeat	Edit - Repeat

Menu	NS-Designer menu command	CX-Designer menu/function
View	Toolbar	View - Toolbar
	Status Bar	View - Status Bar
	Switch Label	View - Previous Label View - Next Label
	Previous Screen	View - Previous Screen
	Next Screen	View - Next Screen
	Previous Frame Page	View - Previous Frame Page
	Next Frame Page	View - Next Frame Page
	Simulate ON/OFF	View - Simulate ON/OFF
	Show ID	View - Show ID
	Show Address	View - Show Address - Show Address
	Show Error Object	Output Window - Data Check Results Tab Page
	Show Sheet Object	View - Show Sheet Object
	Show Touch Points	View - Show Touch Points
	Zoom	View - Zoom
	Refresh	View - Refresh
Functional Object	ON/OFF Button	Functional Object - ON/OFF Button
	Word Button	Functional Object - Word Button
	Command Button	Functional Object - Command Button
	Bit Lamp	Functional Object - Bit Lamp
	Word Lamp	Functional Object - Word Lamp
	Label	Functional Object - Label
	Numeral Display & Input	Functional Object - Numeral Display & Input
	String Display & Input	Functional Object - String Display & Input
	List Selection	Functional Object - List Selection
	Thumbwheel Switch	Functional Object - Thumbwheel Switch
	Analog Meter	Functional Object - Analog Meter
	Level Meter	Functional Object - Level Meter
	Broken-line Graph	Functional Object - Broken-line Graph
	Bitmap	Functional Object - Bitmap
	Alarm/Event Display	Functional Object - Alarm/Event Display
	Alarm/Event Summary & History	Functional Object - Alarm/Event Summary & History
	Date	Functional Object - Date
	Time	Functional Object - Time
	Data Log Graph	Functional Object - Data Log Graph
	Data Log Table	Functional Object - Data Log Table
	Video Display	Functional Object - Video Display
	Frame	Functional Object - Frame
Table	Functional Object - Table	
Temporary Input	Functional Object - Temporary Input	
Fixed Object	Rectangle	Fixed Object - Rectangle
	Circle/Oval	Fixed Object - Circle/Oval
	Straight Line	Fixed Object - Straight Line
	Polyline	Fixed Object - Polyline
	Polygon	Fixed Object - Polygon
	Sector	Fixed Object - Sector
	Arc	Fixed Object - Arc

Menu	NS-Designer menu command	CX-Designer menu/function
Settings	Object Properties	PT - Object Properties
	Edit Label	PT - Edit Label
	Change Settings at Once	Edit - Edit Properties
	Flicker	PT - Flicker
	Password	PT - Password
	Unit/Scale Setting	PT - Unit/Scale
	Alarm/Event Setting	PT - Alarm/Event Setting
	Data Log Setting	PT - Data Log Setting
	Data Block Setting	PT - Data Block Setting
	Change Input Order	PT - Change Input Order
	Project Properties	PT - Project Properties
	Screen Properties	PT - Screen/Sheet Properties
	System Setting	PT - System Setting PT - Communication Setting
	Reset Defined Default	Tool - Reset Defined Default
	Convert	Tool - Convert
Register Hosts	PT - Communication Setting	
Layout	Align/Distribute	Edit - Align/Distribute
	Make Same Size	Edit - Make Same Size
	Order	Edit - Order
	Nudge	Edit - Nudge
	Rotate/Flip	Edit - Rotate/Flip
	Modify	Edit - Edit Node
	Group	Edit - Group - Group
	Ungroup	Edit - Group - Ungroup
	Grid	View - Grid
Tool	Screen Maintenance	Project Workspace - Screen/Sheet Tab Page
	Sheet Maintenance	Project Workspace - Screen/Sheet Tab Page
	Error Check	Tool - Validation
	Validation Result	Output Window - Data Check Results Tab Page
	Functional Object List	Edit - Edit Properties
	List Up Functional Objects Used	View - Window - Select Object
	List Up Addresses Used	View - Window - Address in Use List
	Address Cross Reference	Find - Address Cross Reference
	Edit Background Bitmap	---
	Register Library	Tool - Library
	Use Library	Tool - Library
	Test	Tool - Test
	Resource Report	Tool - Resource Report
Option	Tool - Options	
Window	Cascade	Window - Cascade
	Tile	Window - Tile
	Arrange Icons	Window - Arrange Icons
Help	Contents	Help - Contents
	Search Topic	Help - Search Topic
	About NS-Designer	Help - About CX-Designer

Appendix B

Shortcut Keys

The following tables list the shortcut keys that can be used with CX-Designer.

Menu	Function	Shortcut Keys
File	Open Screen	Ctrl+O
	Save All	Ctrl+S
	New Screen	Ctrl+N
	Save Screen/Sheet	Ctrl+Shift+S
	New Sheet	Ctrl+Shift+N
	Apply Sheet	Ctrl+J
	Print	Ctrl+P
Edit	Undo	Ctrl+Z
	Redo	Ctrl+Y
	Cut	Ctrl+X, Shift+DEL
	Copy	Ctrl+C
	Paste	Ctrl+V, Shift+Ins
	Delete	DEL
	Group	Ctrl+G
	Ungroup	Ctrl+U
	Up	↑ (when object is selected)
	Down	↓ (when object is selected)
	Left	← (when object is selected)
	Right	→ (when object is selected)
	One dot shift	Shift + ↑, ↓, →, or ← (when Snap to Grid is selected)
	All Objects	Ctrl+A
	Same Type Objects	Ctrl+D (when object is selected)
	Repeat	Ctrl+W
	Edit Properties	Ctrl+L
Find	Find	Ctrl+F
	Replace	Ctrl+H
	Address Cross Reference	Ctrl+R
View	Project Workspace	Alt+1
	Symbol Table	Alt+2
	Property List	Alt+3
	Library	Alt+4
	Select Object	Alt+5
	Address in Use List	Alt+6
	Output Window	Alt+7
	Previous Label	Ctrl+PgUp
	Next Label	Ctrl+PgDn
	Previous Screen	Shift+PgUp
	Next Screen	Shift+PgDn
	Previous Frame Page	PgUp (when frame is selected)
	Next Frame Page	PgDn (when frame is selected)
	Refresh	F9

Menu	Function	Shortcut Keys
PT	Quick transfer (Computer → PT)	Ctrl+Q
	Transfer (Computer → PT)	Ctrl+B
	Transfer (PT → Computer)	Ctrl+Shift+B
	Transfer Setting	Ctrl+Alt+B
	Transfer Program	Ctrl+l
	Object Properties	Enter (when functional object is selected)
	Edit Label	Space (when functional object with label setting is selected)
Tool	Test	Ctrl+T
	Validation (Project)	Ctrl+E
	Validation (Current Screen)	Ctrl+Shift+E
	Validation Setting	Ctrl+Alt+E
	Library	Alt+4
Window	Next Window	Alt+0
	Previous Window	Alt+Shift+0

Appendix C

Exchanging Data between NS-series Products

The following tables show the data compatibility between different versions of NS-series products.

Hardware and System Programs

The versions of the system program that can be installed in the PT vary with the model. The possible combinations are shown in the following table. Use a system program that can be installed for the hardware used.

Item	NS12/NS10/ NS7	NS12-V1/ NS10-V1/ NS8-V1/NS5-V1	NS12-V2/ NS10-V2/ NS8-V2 NS5-□0□-V2	NSJ12/10/8/ NSJ5-□□0□ NSH5-SQ□0□	NS5-□□1□-V2 NSJ5-□□1□ NSH5-SQ□1□	NS15-V2
System Program Ver. 1.X	Yes	No	No	No	No	No
System Program Ver. 2.X	Yes	No	No	No	No	No
System Program Ver. 3.X	Yes	No	No	No	No	No
System Program Ver. 4.X	No	Yes (Not for NS5-V1)	No	No	No	No
System Program Ver. 5.X	No	Yes	No	No	No	No
System Program Ver. 6.0	No	Yes	No	No	No	No
System Program Ver. 6.2	No	Yes	Yes	No	No	No
System Program Ver. 6.5	No	No	No	Yes	No	No
System Program Ver. 6.6	No	Yes	Yes	Yes	No	No
System Program Ver. 7.0	No	Yes	Yes	Yes	No	No
System Program Ver. 8.0	No	Yes	Yes	Yes	Yes	No
System Program Ver. 8.1	No	Yes	Yes	Yes	Yes	Yes
System Program Ver. 8.2	No	Yes	Yes	Yes	Yes	Yes
System Program Ver. 8.3	No	Yes	Yes	Yes	Yes	Yes
System Program Ver. 8.4	No	Yes	Yes	Yes	Yes	Yes
System Program Ver. 8.5	No	Yes	Yes	Yes	Yes	Yes
System Program Ver. 8.6	No	Yes	Yes	Yes	Yes	Yes
System Program Ver. 8.7	No	Yes	Yes	Yes	Yes	Yes
System Program Ver. 8.8	No	Yes	Yes	Yes	Yes	Yes
System Program Ver. 8.9	No	Yes	Yes	Yes	Yes	Yes

Yes: Can be installed, No: Cannot be installed

System Programs and Screen Data Versions

The versions of project data that can be used on the PT depend on the version of the system program installed in the PT. The “project data version” is the version of the program selected when screen data is created on CX-Designer. The combinations that can be used on the PT are shown in the following table. Project data versions are upwardly compatible.

Item		System program							
		Ver. 1.X	Ver. 2.X	Ver. 3.X	Ver. 4.X	Ver. 5.X	Ver. 6.0	Ver. 6.2	Ver. 6.5
Project Data Versions	Ver. 1.X	Yes	Yes	Yes	Yes	Yes	Yes	Yes	No
	Ver. 2.X	No	Yes	Yes	Yes	Yes	Yes	Yes	No
	Ver. 3.X	No	No	Yes	Yes	Yes	Yes	Yes	No
	Ver. 4.X	No	No	No	Yes	Yes	Yes	Yes	No
	Ver. 5.X	No	No	No	No	Yes	Yes	Yes	No
	Ver. 6.0	No	No	No	No	No	Yes	Yes	No
	Ver. 6.2	No	No	No	No	No	No	Yes	No
	Ver. 6.5	No	No	No	No	No	No	No	Yes
	Ver. 6.6	No	No	No	No	No	No	No	No
	Ver. 6.7	No	No	No	No	No	No	No	No
	Ver. 7.0	No	No	No	No	No	No	No	No
	Ver. 7.1	No	No	No	No	No	No	No	No
	Ver. 8.0	No	No	No	No	No	No	No	No
	Ver. 8.1	No	No	No	No	No	No	No	No
	Ver. 8.2	No	No	No	No	No	No	No	No
	Ver. 8.3	No	No	No	No	No	No	No	No
	Ver. 8.4	No	No	No	No	No	No	No	No
	Ver. 8.5	No	No	No	No	No	No	No	No
	Ver. 8.6	No	No	No	No	No	No	No	No
	Ver. 8.7	No	No	No	No	No	No	No	No
Ver. 8.8	No	No	No	No	No	No	No	No	
Ver. 8.9	No	No	No	No	No	No	No	No	

Item		System program								
		Ver. 6.6	Ver. 7.0	Ver. 8.0	Ver. 8.1	Ver. 8.2	Ver. 8.3	Ver. 8.4	Ver. 8.5	Ver. 8.6
Project Data Versions	Ver. 1.X	Yes	Yes	Yes	Yes	Yes	Yes	Yes	Yes	Yes
	Ver. 2.X	Yes	Yes	Yes	Yes	Yes	Yes	Yes	Yes	Yes
	Ver. 3.X	Yes	Yes	Yes	Yes	Yes	Yes	Yes	Yes	Yes
	Ver. 4.X	Yes	Yes	Yes	Yes	Yes	Yes	Yes	Yes	Yes
	Ver. 5.X	Yes	Yes	Yes	Yes	Yes	Yes	Yes	Yes	Yes
	Ver. 6.0	Yes	Yes	Yes	Yes	Yes	Yes	Yes	Yes	Yes
	Ver. 6.2	Yes	Yes	Yes	Yes	Yes	Yes	Yes	Yes	Yes
	Ver. 6.5	Yes	Yes	Yes	Yes	Yes	Yes	Yes	Yes	Yes
	Ver. 6.6	Yes	Yes	Yes	Yes	Yes	Yes	Yes	Yes	Yes
	Ver. 6.7	No	Yes	Yes	Yes	Yes	Yes	Yes	Yes	Yes
	Ver. 7.0	No	Yes	Yes	Yes	Yes	Yes	Yes	Yes	Yes
	Ver. 7.1	No	No	Yes	Yes	Yes	Yes	Yes	Yes	Yes
	Ver. 8.0	No	No	Yes	Yes	Yes	Yes	Yes	Yes	Yes
	Ver. 8.1	No	No	No	Yes	Yes	Yes	Yes	Yes	Yes
	Ver. 8.2	No	No	No	No	Yes	Yes	Yes	Yes	Yes
	Ver. 8.3	No	No	No	No	No	Yes	Yes	Yes	Yes
	Ver. 8.4	No	No	No	No	No	No	Yes	Yes	Yes
	Ver. 8.5	No	No	No	No	No	No	No	Yes	Yes
	Ver. 8.6	No	No	No	No	No	No	No	No	Yes
Ver. 8.7	No	No	No	No	No	No	No	No	No	
Ver. 8.8	No	No	No	No	No	No	No	No	No	
Ver. 8.9	No	No	No	No	No	No	No	No	No	

Yes: Can be used on the PT, No: Cannot be used on the PT

Note With the NSJ12, NSJ10, NSJ8, NSJ5, and NSH5, operation is possible only if the project data version has been converted to 6.5 or higher.

Item		System program		
		Ver. 8.7	Ver. 8.8	Ver. 8.9
Project Data Versions	Ver. 1.X	Yes	Yes	Yes
	Ver. 2.X	Yes	Yes	Yes
	Ver. 3.X	Yes	Yes	Yes
	Ver. 4.X	Yes	Yes	Yes
	Ver. 5.X	Yes	Yes	Yes
	Ver. 6.0	Yes	Yes	Yes
	Ver. 6.2	Yes	Yes	Yes
	Ver. 6.3	Yes	Yes	Yes
	Ver. 6.4	Yes	Yes	Yes
	Ver. 6.5	Yes	Yes	Yes
	Ver. 6.6	Yes	Yes	Yes
	Ver. 6.7	Yes	Yes	Yes
	Ver. 7.0	Yes	Yes	Yes
	Ver. 7.1	Yes	Yes	Yes
	Ver. 8.0	Yes	Yes	Yes
	Ver. 8.1	Yes	Yes	Yes
	Ver. 8.2	Yes	Yes	Yes
	Ver. 8.3	Yes	Yes	Yes
	Ver. 8.4	Yes	Yes	Yes
	Ver. 8.5	Yes	Yes	Yes
Ver. 8.6	Yes	Yes	Yes	
Ver. 8.7	Yes	Yes	Yes	
Ver. 8.8	No	Yes	Yes	
Ver. 8.9	No	No	Yes	

Yes: Can be operated on the NS Unit, No: Can not be operated on the NS

Note With the NSJ12/10/8/5 and NSH5, operation is possible only if the project data version has been converted to 6.5 or higher.

CX-Designer and Project Data Versions

The versions of screen data that can be read and created depend on the CX-Designer version. Convert the data as required with CX-Designer before reading it.

Item		CX-Designer								
		Version 1.0	Version 2.0	Version 2.1	Version 3.0	Version 3.007	Version 3.1	Version 3.2	Version 3.3	Version 3.4
Project Data Versions	Ver. 1.X	Yes (See note 1.)	Yes (See note 1.)	Yes (See note 1.)	Yes (See note 1.)	Yes (See note 1.)	Yes (See note 1.)	Yes (See note 1.)	Yes (See note 1.)	Yes (See note 1.)
	Ver. 2.X	Yes	Yes	Yes	Yes	Yes	Yes	Yes	Yes	Yes
	Ver. 3.X	Yes	Yes	Yes	Yes	Yes	Yes	Yes	Yes	Yes
	Ver. 4.X	Yes	Yes	Yes	Yes	Yes	Yes	Yes	Yes	Yes
	Ver. 5.X	Yes	Yes	Yes	Yes	Yes	Yes	Yes	Yes	Yes
	Ver. 6.0	Yes	Yes	Yes	Yes	Yes	Yes	Yes	Yes	Yes
	Ver. 6.2	Yes	Yes	Yes	Yes	Yes	Yes	Yes	Yes	Yes
	Ver. 6.3	No	Yes	Yes	Yes	Yes	Yes	Yes	Yes	Yes
	Ver. 6.4	No	Yes	Yes	Yes	Yes	Yes	Yes	Yes	Yes
	Ver. 6.5	Yes	Yes	Yes	Yes	Yes	Yes	Yes	Yes	Yes
	Ver. 6.6	No	Yes	Yes	Yes	Yes	Yes	Yes	Yes	Yes
	Ver. 6.7	No	No	Yes	Yes	Yes	Yes	Yes	Yes	Yes
	Ver. 7.0	No	No	Yes	Yes	Yes	Yes	Yes	Yes	Yes
	Ver. 7.1	No	No	Yes	Yes	Yes	Yes	Yes	Yes	Yes
	Ver. 8.0	No	No	No	Yes	Yes	Yes	Yes	Yes	Yes
	Ver. 8.1	No	No	No	No	Yes (See note 2.)	Yes	Yes	Yes	Yes
	Ver. 8.2	No	No	No	No	No	Yes	Yes	Yes	Yes
	Ver. 8.3	No	No	No	No	No	No	Yes	Yes	Yes
	Ver. 8.4	No	No	No	No	No	No	Yes	Yes	Yes
	Ver. 8.5	No	No	No	No	No	No	No	Yes	Yes
Ver. 8.6	No	No	No	No	No	No	No	No	Yes	
Ver. 8.7	No	No	No	No	No	No	No	No	No	
Ver. 8.8	No	No	No	No	No	No	No	No	No	
Ver. 8.9	No	No	No	No	No	No	No	No	No	

Yes: Can be read, No: Cannot be read

- Note** (1) Screen data can be read only if a Japanese operating system is used.
 (2) CX-Designer Ver. 3.008 for NS15 only.

Item		CX-Designer		
		Ver. 3.58	Ver. 3.62	Ver. 3.64
Project Data Versions	Ver. 1.X	Yes	Yes	Yes
	Ver. 2.X	Yes	Yes	Yes
	Ver. 3.X	Yes	Yes	Yes
	Ver. 4.X	Yes	Yes	Yes
	Ver. 5.X	Yes	Yes	Yes
	Ver. 6.0	Yes	Yes	Yes
	Ver. 6.2	Yes	Yes	Yes
	Ver. 6.3	Yes	Yes	Yes
	Ver. 6.4	Yes	Yes	Yes
	Ver. 6.5	Yes	Yes	Yes
	Ver. 6.6	Yes	Yes	Yes
	Ver. 6.7	Yes	Yes	Yes
	Ver. 7.0	Yes	Yes	Yes
	Ver. 7.1	Yes	Yes	Yes
	Ver. 8.0	Yes	Yes	Yes
	Ver. 8.1	Yes	Yes	Yes
	Ver. 8.2	Yes	Yes	Yes
	Ver. 8.3	Yes	Yes	Yes
	Ver. 8.4	Yes	Yes	Yes
	Ver. 8.5	Yes	Yes	Yes
Ver. 8.6	Yes	Yes	Yes	
Ver. 8.7	Yes	Yes	Yes	
Ver. 8.8	No	Yes	Yes	
Ver. 8.9	No	No	Yes	

Yes: Can be read, No: Cannot be read

Revision History

A manual revision code appears as a suffix to the catalog number on the front cover of the manual.

Cat. No. V099-E1-11



Revision code

The following table outlines the changes made to the manual during each revision. Page numbers refer to the previous version.

Revision code	Date	Revised content
01	June 2008	Original production
02	October 2008	Changes related to version upgrade.
03	November 2008	Changes related to model additions to NS Series.
04	April 2009	Changes related to version upgrade.
05	December 2009	Additions related to Windows 7.
06	October 2010	Changes related to version upgrade.
07	July 2011	Changes for support for NJ-series Controllers.
08	April 2012	Changes related to support for integrated simulation with the Sysmac Studio.
09	September 2013	Additions related to Windows 8.
10	April 2015	Revision of support for NX Series.
11	April 2016	Revisions related to change in CX-One model number.

Revision History

OMRON Corporation Industrial Automation Company

Kyoto, JAPAN

Contact: www.ia.omron.com

Regional Headquarters

OMRON EUROPE B.V.

Wegalaan 67-69, 2132 JD Hoofddorp
The Netherlands

Tel: (31)2356-81-300/Fax: (31)2356-81-388

OMRON ELECTRONICS LLC

2895 Greenspoint Parkway, Suite 200
Hoffman Estates, IL 60169 U.S.A.

Tel: (1) 847-843-7900/Fax: (1) 847-843-7787

OMRON ASIA PACIFIC PTE. LTD.

No. 438A Alexandra Road # 05-05/08 (Lobby 2),
Alexandra Technopark,

Singapore 119967

Tel: (65) 6835-3011/Fax: (65) 6835-2711

OMRON (CHINA) CO., LTD.

Room 2211, Bank of China Tower,
200 Yin Cheng Zhong Road,

PuDong New Area, Shanghai, 200120, China

Tel: (86) 21-5037-2222/Fax: (86) 21-5037-2200

Authorized Distributor:

© OMRON Corporation 2008-2016 All Rights Reserved.
In the interest of product improvement,
specifications are subject to change without notice.

Cat. No. V099-E1-11

0416