

AC Servo Drives

DC Power Input Σ -V Series

USER'S MANUAL

Setup

Rotational Motor

SGDV SERVOPACK
SGMMV Servomotor

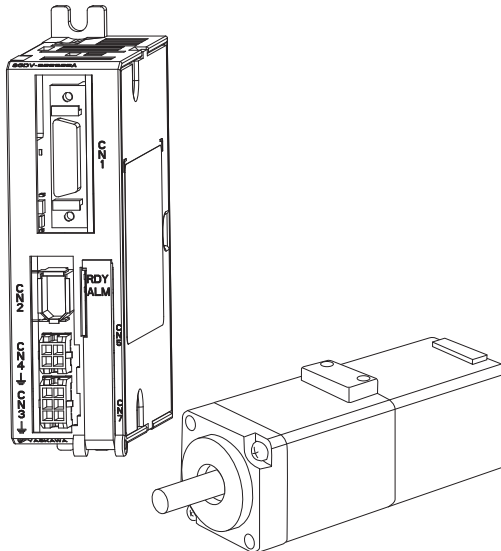

Overview of Setup **1**

Installation **2**

Wiring and Connection **3**

Trial Operation
(Checking Servomotor Operation) **4**

Copyright © 2011 YASKAWA ELECTRIC CORPORATION

All rights reserved. No part of this publication may be reproduced, stored in a retrieval system, or transmitted, in any form, or by any means, mechanical, electronic, photocopying, recording, or otherwise, without the prior written permission of Yaskawa. No patent liability is assumed with respect to the use of the information contained herein. Moreover, because Yaskawa is constantly striving to improve its high-quality products, the information contained in this manual is subject to change without notice. Every precaution has been taken in the preparation of this manual. Nevertheless, Yaskawa assumes no responsibility for errors or omissions. Neither is any liability assumed for damages resulting from the use of the information contained in this publication.

About this Manual

This manual describes procedures required for installation, wiring, and connecting DC power input Σ -V Series servo drives, including a JOG operation for servomotors not connected to machinery.

Be sure to refer to this manual and perform setup operations correctly.

Keep this manual in a location where it can be accessed for reference whenever required.

■ Description of Technical Terms

The following table shows the meanings of terms used in this manual.

Term	Meaning
Servomotor	Σ -Vmini Series SGMMV servomotor
SERVOPACK	DC power input Σ -V Series SGD V SERVOPACK
Servo Drive	A set including a servomotor and a SERVOPACK (i.e., a servo amplifier)
Servo System	A servo control system that includes the combination of a servo drive with a host controller and peripheral devices
Analog voltage model	Analog voltage reference is used for the SERVOPACK interface.
Pulse train model	Pulse train reference is used for the SERVOPACK interface.
M-II model	MECHATROLINK-II communications reference is used for the SERVOPACK interface.
M-III model	MECHATROLINK-III communications reference is used for the SERVOPACK interface.

■ Important Explanations

The following icon is displayed for explanations requiring special attention.



- Indicates important information that should be memorized, as well as precautions, such as alarm displays, that do not involve potential damage to equipment.

■ Notation Used in this Manual

In this manual, the names of reverse signals (ones that are valid when low) are written with a forward slash (/) before the signal name, as shown in the following example:

Example

$\overline{\text{S-ON}}$ = /S-ON

■ Manuals Related to the DC Power Input Σ -V Series

Refer to the following manuals as required.

Name	Selecting Models and Peripheral Devices	Ratings and Specifications	System Design	Panels and Wiring	Trial Operation	Trial Operation and Servo Adjustment	Maintenance and Inspection
Σ -V Series Product Catalog (KAEP S800000 42)	✓	✓					
DC Power Input Σ -V Series User's Manual Design and Maintenance Rotational Motor/ Analog Voltage Reference and Pulse Train Reference (SIEP S800000 81)		✓	✓	✓		✓	✓
DC Power Input Σ -V Series User's Manual Design and Maintenance Rotational Motor/ MECHATROLINK-II Communications Reference (SIEP S800000 82)		✓	✓	✓		✓	✓
Σ -V Series User's Manual MECHATROLINK-II Command (SIEP S800000 54)			✓		✓	✓	
Σ -V Series User's Manual Operation of Digital Operator (SIEP S800000 55)					✓	✓	✓
Σ -V Series User's Manual MECHATROLINK-III Command (SIEP S800000 63)			✓		✓	✓	

(cont'd)

Name	Selecting Models and Peripheral Devices	Ratings and Specifications	System Design	Panels and Wiring	Trial Operation	Trial Operation and Servo Adjustment	Maintenance and Inspection
DC Power Input Σ-V Series User's Manual Design and Maintenance Rotational Motor/ MECHATROLINK-III Communications Reference (SIEP S800000 83)		✓	✓	✓		✓	✓
AC SERVOMOTOR Safety Precautions (TOBP C230200 00)				✓			✓
DC Power Input Σ-V Series AC SERVOPACK SGDV Safety Precautions (TOBP C710829 06)	✓			✓			✓
Σ Series Digital Operator Safety Precautions (TOBP C730800 00)							✓

■ Safety Information

The following conventions are used to indicate precautions in this manual. Failure to heed precautions provided in this manual can result in serious or possibly even fatal injury or damage to the products or to related equipment and systems.

**WARNING**

Indicates precautions that, if not heeded, could possibly result in loss of life or serious injury.

**CAUTION**

Indicates precautions that, if not heeded, could result in relatively serious or minor injury, damage to the product, or faulty operation.

In some situations, the precautions indicated could have serious consequences if not heeded.

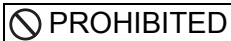
**PROHIBITED**

Indicates prohibited actions that must not be performed. For example, this symbol would be used to indicate that fire is prohibited as follows: 

**MANDATORY**

Indicates compulsory actions that must be performed. For example, this symbol would be used as follows to indicate that grounding is compulsory: 



Safety Precautions

This section describes important precautions that must be followed during storage, transportation, installation, wiring, operation, maintenance, inspection, and disposal. Be sure to always observe these precautions thoroughly.

WARNING

- **Never touch any rotating servomotor parts during operation.**
Failure to observe this warning may result in injury.
- **Before starting operation with a machine connected, make sure that an emergency stop can be applied at any time.**
Failure to observe this warning may result in injury or damage to the equipment.
- **Never touch the inside of the SERVOPACKS.**
Failure to observe this warning may result in electric shock.
- **Immediately after the power is turned OFF or after a voltage resistance test, do not touch terminals.**
Residual voltage may cause electric shock.
- **Follow the procedures and instructions provided in the manuals for the products being used in the trial operation.**
Failure to do so may result not only in faulty operation and damage to equipment, but also in personal injury.
- **The multiturn limit value need not be changed except for special applications.**
Changing it inappropriately or unintentionally can be dangerous.
- **If the Multiturn Limit Disagreement alarm occurs, check the setting of parameter Pn205 in the SERVOPACK to be sure that it is correct.**
If Fn013 is executed when an incorrect value is set in Pn205, an incorrect value will be set in the encoder. The alarm will disappear even if an incorrect value is set, but incorrect positions will be detected, resulting in a dangerous situation where the machine will move to unexpected positions.
- **Do not remove the cables or connectors from the SERVOPACK while the power is ON.**
Failure to observe this warning may result in electric shock.
- **Do not damage, pull, exert excessive force on, or place heavy objects on the cables.**
Failure to observe this warning may result in electric shock, stopping operation of the product, or fire.
- **Do not modify the product.**
Failure to observe this warning may result in injury, damage to the equipment, or fire.
- **Provide appropriate braking devices on the machine side to ensure safety.**
The holding brake on a servomotor with a brake is not a braking device for ensuring safety.
Failure to observe this warning may result in injury.
- **Do not come close to the machine immediately after resetting an instantaneous power interruption to avoid an unexpected restart. Take appropriate measures to ensure safety against an unexpected restart.**
Failure to observe this warning may result in injury.

WARNING

-  • Connect the ground terminal according to local electrical codes (100 Ω or less).
Improper grounding may result in electric shock or fire.
-  • Installation, disassembly, or repair must be performed only by authorized personnel.
Failure to observe this warning may result in electric shock or injury.

■ Storage and Transportation

CAUTION

- Do not store or install the product in the following locations.
Failure to observe this caution may result in fire, electric shock, or damage to the equipment.
 - Locations subject to direct sunlight
 - Locations subject to temperatures outside the range specified in the storage/installation temperature conditions
 - Locations subject to humidity outside the range specified in the storage/installation humidity conditions
 - Locations subject to condensation as the result of extreme changes in temperature
 - Locations subject to corrosive or flammable gases
 - Locations subject to dust, salts, or iron dust
 - Locations subject to exposure to water, oil, or chemicals
 - Locations subject to shock or vibration
- Do not hold the product by the cables, motor shaft, or encoder while transporting it.
Failure to observe this caution may result in injury or malfunction.
- Do not place any load exceeding the limit specified on the packing box.
Failure to observe this caution may result in injury or malfunction.
- If disinfectants or insecticides must be used to treat packing materials such as wooden frames, pallets, or plywood, the packing materials must be treated before the product is packaged, and methods other than fumigation must be used.
Example: Heat treatment, where materials are kiln-dried to a core temperature of 56°C for 30 minutes or more.
If the electronic products, which include stand-alone products and products installed in machines, are packed with fumigated wooden materials, the electrical components may be greatly damaged by the gases or fumes resulting from the fumigation process. In particular, disinfectants containing halogen, which includes chlorine, fluorine, bromine, or iodine can contribute to the erosion of the capacitors.

■ Installation

CAUTION

- **Never use the product in an environment subject to water, corrosive gases, flammable gases, or combustibles.**
Failure to observe this caution may result in electric shock or fire.
- **Do not step on or place a heavy object on the product.**
Failure to observe this caution may result in injury or malfunction.
- **Do not cover the inlet or outlet ports and prevent any foreign objects from entering the product.**
Failure to observe this caution may cause internal elements to deteriorate resulting in malfunction or fire.
- **Be sure to install the product in the correct direction.**
Failure to observe this caution may result in malfunction.
- **Provide the specified clearances between the SERVOPACK and the control panel or with other devices.**
Failure to observe this caution may result in fire or malfunction.
- **Do not apply any strong impact.**
Failure to observe this caution may result in malfunction.

■ Wiring

CAUTION

- **Be sure to wire correctly and securely.**
Failure to observe this caution may result in motor overrun, injury, or malfunction.
- **Do not connect a commercial power supply to the U, V, or W terminals for the servomotor connection.**
Failure to observe this caution may result in injury or fire.
- **Securely connect the main circuit terminals.**
Failure to observe this caution may result in fire.
- **Do not bundle or run the servomotor main circuit cables together with the I/O signal cables or the encoder cables in the same duct. Keep the servomotor main circuit cables separated from the I/O signal cables and encoder cables by at least 30 cm.**
Placing these cables too close to each other may result in malfunction.
- **Use shielded twisted-pair cables or screened unshielded twisted-pair cables for I/O signal cables and the encoder cables.**
- **The maximum wiring length is 3 m for I/O signal cables, 50 m for servomotor main circuit cables and encoder cables, and 10 m for power supply cables.**
- **Install the battery in the battery unit of the encoder cable with a battery unit.**
- **Voltage remains in the SERVOPACK even after the power supply is turned OFF. To prevent electric shock, do not touch the input terminals for the main circuit power supply or those for the control power supply.**
Before wiring or inspections, confirm that the SERVOPACK has completely discharged.

CAUTION

- Be sure to observe the following precautions when wiring the SERVOPACK main circuit terminal blocks.
 - Do not turn the SERVOPACK power ON until all wiring, including the main circuit terminal blocks, has been completed.
 - Remove detachable power supply input connectors or motor connectors from the SERVOPACK before wiring.
- Make sure that the wiring for both the main circuit power supply and control power supply is correct.
Incorrect wiring may cause damage.
- Make sure that the polarity of the input power supply is correct.
Incorrect polarity may cause damage.
- Always use the specified power supply voltage.
An incorrect voltage may result in fire or malfunction.
- Take appropriate measures to ensure that the input power supply is supplied within the specified voltage fluctuation range.
An incorrect power supply may result in damage to the equipment.
- Install external breakers or other safety devices against short-circuiting in external wiring.
Failure to observe this caution may result in fire.
- Take appropriate and sufficient countermeasures for each form of potential interference when installing systems in the following locations.
 - Locations subject to static electricity or other forms of noise
 - Locations subject to strong electromagnetic fields and magnetic fields
 - Locations subject to possible exposure to radioactivity
 - Locations close to power suppliesFailure to observe this caution may result in damage to the equipment.
- Do not reverse the polarity of the battery when connecting it.
Failure to observe this caution may damage the battery, the SERVOPACK or servomotor, or cause an explosion.
- Wiring or inspection must be performed by a technical expert.
- Use a 24-VDC or 48-VDC power supply with double insulation or reinforced insulation.
- Failures caused by incorrect wiring or wrong voltage application in the brake circuit may damage the equipment or cause an accident resulting in death or injury. Follow the procedures and instructions for wiring and trial operation precisely as described in this manual.
- When using a detector or a breaker for leakage current, select the appropriate one by considering the grounding conditions and the leakage current of noise filter. For details, contact the manufacturer of the noise filter.
- Incorrect wiring or incorrect voltage application to the output circuit may cause short-circuit.
The above failures will prevent the holding brake from working, which may damage the machine or cause an accident resulting in death or injury.
- Inverting the polarity of the brake signal (/BK), i.e. positive logic, will prevent the holding brake from working in case of its signal line disconnection. If this setting is absolutely necessary, check the operation and confirm that there are no safety problems.
- Provide separate AC/DC power supplies for the main circuits and for controls.
Failure to observe this caution may result in malfunction.

CAUTION

- Do not connect devices (such as motors or solenoids) that greatly change the load or devices (such as electromagnetic switches) that generate surge voltages to the controller power line.
Failure to observe this caution may result in deterioration of the internal elements or a blown fuse.

■ Operation

CAUTION

- Always use the servomotor and SERVOPACK in one of the specified combinations.
Failure to observe this caution may result in fire or malfunction.
- Conduct trial operation on the servomotor alone with the motor shaft disconnected from the machine to avoid accidents.
Failure to observe this caution may result in injury.
- During trial operation, confirm that the holding brake works correctly. Furthermore, secure system safety against problems such as signal line disconnection.
- Before starting operation with a machine connected, change the parameter settings to match the parameters of the machine.
Starting operation without matching the proper settings may cause the machine to run out of control or malfunction.
- Do not turn the power ON and OFF more than necessary.
Do not use the SERVOPACK for applications that require the power to turn ON and OFF frequently. Such applications will cause elements in the SERVOPACK to deteriorate.
As a guideline, at least one hour should be allowed between the power being turned ON and OFF once actual operation has been started.
- When carrying out JOG operation (Fn002), origin search (Fn003), or Easy-FFT (Fn206), forcing movable machine parts to stop does not work for forward overtravel or reverse overtravel. Take necessary precautions.
Failure to observe this caution may result in damage to the equipment.
- When using the servomotor for a vertical axis, install safety devices to prevent workpieces from falling due to alarms or overtravels. Set the servomotor so that it will stop in the zero clamp state when overtravel occurs.
Failure to observe this caution may cause workpieces to fall due to overtravel.
- When not using the tuning-less function, set the correct moment of inertia ratio (Pn103).
Setting an incorrect moment of inertia ratio may cause machine vibration.
- Do not touch the SERVOPACK heat sinks or servomotor while power is ON or soon after the power is turned OFF.
Failure to observe this caution may result in burns due to high temperatures.
- Do not make any extreme adjustments or setting changes of parameters.
Failure to observe this caution may result in injury or damage to the equipment due to unstable operation.
- When an alarm occurs, remove the cause, reset the alarm after confirming safety, and then resume operation.
Failure to observe this caution may result in damage to the equipment, fire, or injury.

 CAUTION

- Do not use the holding brake of the servomotor for braking. Failure to observe this caution may result in malfunction.
- The servomotor will decelerate to a stop if the main-circuit or the control-circuit power supply turns OFF during operation without turning servo OFF.
- An alarm or warning may occur if communications are performed with the host controller while the SigmaWin+ or Digital Operator is operating. If an alarm or warning occurs, it may stop the current process and stop the system.

■ Maintenance and Inspection

 CAUTION

- Do not disassemble the SERVOPACK and the servomotor. Failure to observe this caution may result in electric shock or injury.
- Do not attempt to change wiring while the power is ON. Failure to observe this caution may result in electric shock or injury.
- When replacing the SERVOPACK, resume operation only after copying the previous SERVOPACK parameters to the new SERVOPACK. Failure to observe this caution may result in damage to the equipment.

■ Disposal

 CAUTION

- When disposing of the products, treat them as ordinary industrial waste.

■ General Precautions

Observe the following general precautions to ensure safe application.

- The products shown in illustrations in this manual are sometimes shown without covers or protective guards. Always replace the cover or protective guard as specified first, and then operate the products in accordance with the manual.
- The drawings presented in this manual are typical examples and may not match the product you received.
- If the manual must be ordered due to loss or damage, inform your nearest Yaskawa representative or one of the offices listed on the back of this manual.

Warranty

(1) Details of Warranty

■ Warranty Period

The warranty period for a product that was purchased (hereafter called “delivered product”) is one year from the time of delivery to the location specified by the customer or 18 months from the time of shipment from the Yaskawa factory, whichever is sooner.

■ Warranty Scope

Yaskawa shall replace or repair a defective product free of charge if a defect attributable to Yaskawa occurs during the warranty period above. This warranty does not cover defects caused by the delivered product reaching the end of its service life and replacement of parts that require replacement or that have a limited service life.

This warranty does not cover failures that result from any of the following causes.

1. Improper handling, abuse, or use in unsuitable conditions or in environments not described in product catalogs or manuals, or in any separately agreed-upon specifications
2. Causes not attributable to the delivered product itself
3. Modifications or repairs not performed by Yaskawa
4. Abuse of the delivered product in a manner in which it was not originally intended
5. Causes that were not foreseeable with the scientific and technological understanding at the time of shipment from Yaskawa
6. Events for which Yaskawa is not responsible, such as natural or human-made disasters

(2) Limitations of Liability

1. Yaskawa shall in no event be responsible for any damage or loss of opportunity to the customer that arises due to failure of the delivered product.
2. Yaskawa shall not be responsible for any programs (including parameter settings) or the results of program execution of the programs provided by the user or by a third party for use with programmable Yaskawa products.
3. The information described in product catalogs or manuals is provided for the purpose of the customer purchasing the appropriate product for the intended application. The use thereof does not guarantee that there are no infringements of intellectual property rights or other proprietary rights of Yaskawa or third parties, nor does it construe a license.
4. Yaskawa shall not be responsible for any damage arising from infringements of intellectual property rights or other proprietary rights of third parties as a result of using the information described in catalogs or manuals.

(3) Suitability for Use

1. It is the customer's responsibility to confirm conformity with any standards, codes, or regulations that apply if the Yaskawa product is used in combination with any other products.
2. The customer must confirm that the Yaskawa product is suitable for the systems, machines, and equipment used by the customer.
3. Consult with Yaskawa to determine whether use in the following applications is acceptable. If use in the application is acceptable, use the product with extra allowance in ratings and specifications, and provide safety measures to minimize hazards in the event of failure.
 - Outdoor use, use involving potential chemical contamination or electrical interference, or use in conditions or environments not described in product catalogs or manuals
 - Nuclear energy control systems, combustion systems, railroad systems, aviation systems, vehicle systems, medical equipment, amusement machines, and installations subject to separate industry or government regulations
 - Systems, machines, and equipment that may present a risk to life or property
 - Systems that require a high degree of reliability, such as systems that supply gas, water, or electricity, or systems that operate continuously 24 hours a day
 - Other systems that require a similar high degree of safety
4. Never use the product for an application involving serious risk to life or property without first ensuring that the system is designed to secure the required level of safety with risk warnings and redundancy, and that the Yaskawa product is properly rated and installed.
5. The circuit examples and other application examples described in product catalogs and manuals are for reference. Check the functionality and safety of the actual devices and equipment to be used before using the product.
6. Read and understand all use prohibitions and precautions, and operate the Yaskawa product correctly to prevent accidental harm to third parties.

(4) Specifications Change

The names, specifications, appearance, and accessories of products in product catalogs and manuals may be changed at any time based on improvements and other reasons. The next editions of the revised catalogs or manuals will be published with updated code numbers. Consult with your Yaskawa representative to confirm the actual specifications before purchasing a product.

Applicable Standards

■ North American Safety Standards (UL)



	Model	UL * Standards
SERVOPACK	SGDV	UL508C
Servomotor	SGMMV	UL1004

* Underwriters Laboratories Inc.

■ European Standards (EC)



	Model	Low Voltage Directive	EMC Directive	
			EMI	EMS
SERVOPACK	SGDV	EN61800-5-1	EN55011 group 1 class A EN61800-3	EN61800-3 EN61000-6-2
Servomotor	SGMMV	IEC60034-1 IEC60034-5 IEC60034-8 IEC60034-9	EN55011 group 1 class A EN61800-3	EN61800-3 EN61000-6-2

Note: Because SERVOPACKs and servomotors are built into machines, certification is required after installation in the user's product.

Contents

About this Manual	iii
Safety Precautions	vi
Warranty	xii
Applicable Standards	xiv
1 Overview of Setup	1-1
2 Installation	2-1
2.1 Installation Environment and Applicable Standards	2-2
2.1.1 Servomotor Installation Environment	2-2
2.1.2 SERVOPACK Installation Environment	2-3
2.1.3 Installation Conditions for Applicable Standards	2-4
2.2 Servomotor Installation	2-5
2.2.1 Orientation	2-5
2.2.2 Installation Standards	2-5
2.2.3 Connecting Servomotor to Machine	2-6
2.2.4 Protective Structure	2-7
2.2.5 Other Precautions	2-8
2.3 SERVOPACK Installation	2-9
2.3.1 Orientation	2-9
2.3.2 Installation Standards	2-10
2.4 EMC Installation Conditions	2-11
2.4.1 SGD□V-□□□E21A (M-III Model)	2-11
2.4.2 Other Precautions	2-12
3 Wiring and Connection	3-1
3.1 Precautions for Wiring	3-2
3.2 System Configuration Diagram	3-3
3.2.1 Connecting to SGD□V-□□□E□1A SERVOPACK (Analog Voltage/Pulse Train Model)	3-3
3.2.2 Connecting to SGD□V-□□□E11A SERVOPACK (M-II Model)	3-4
3.2.3 Connecting to SGD□V-□□□E21A SERVOPACK (M-III Model)	3-5
3.3 Main Circuit Wiring	3-6
3.3.1 Names and Functions of Main Circuit Terminals	3-6
3.3.2 SERVOPACK Main Circuit Cable	3-7
3.3.3 Typical Main Circuit Wiring Examples	3-9
4 Trial Operation (Checking Servomotor Operation)	4-1
4.1 Outline	4-2
4.2 Inspection and Checking before Trial Operation	4-3
4.3 JOG Operation Using a Digital Operator	4-6
4.4 JOG Operation Using SigmaWin+	4-9

Revision History

Overview of Setup

This chapter describes how to set up the DC power input Σ -V series of servo drives.

This chapter describes the flow of the setup procedure from installation until a JOG operation. A digital operator and an engineering tool called SigmaWin+ that can be used with a PC are available to set up a servo drive.

 CAUTION
<ul style="list-style-type: none"> An alarm or warning may be generated if communications are executed with the host controller during operation using SigmaWin+ or the digital operator. If an alarm or warning is generated, the process currently being executed may be aborted and the system may stop.

 IMPORTANT	<ul style="list-style-type: none"> Be sure to read <i>4.2 Inspection and Checking before Trial Operation</i>. The digital operator is available for both SERVOPACKs with analog voltage reference and SERVOPACKs with pulse train reference.
--	--

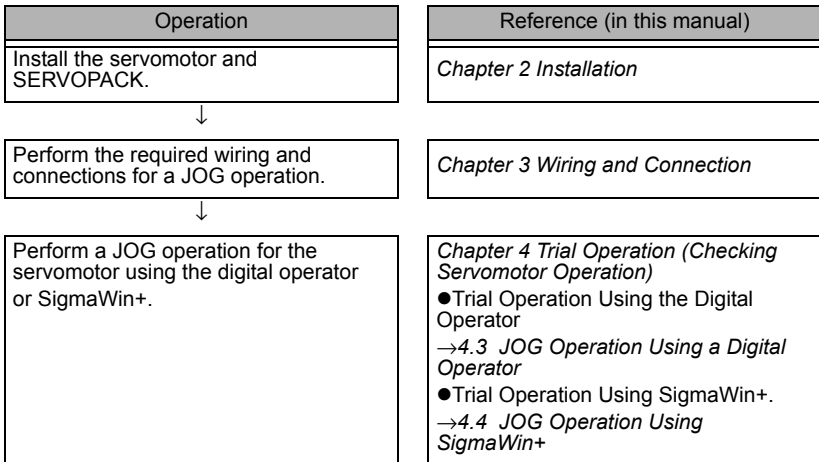

Installation

This chapter describes how to install the servomotor and the SERVOPACK.

2.1	Installation Environment and Applicable Standards	2-2
2.1.1	Servomotor Installation Environment	2-2
2.1.2	SERVOPACK Installation Environment	2-3
2.1.3	Installation Conditions for Applicable Standards	2-4
2.2	Servomotor Installation	2-5
2.2.1	Orientation	2-5
2.2.2	Installation Standards	2-5
2.2.3	Connecting Servomotor to Machine	2-6
2.2.4	Protective Structure	2-7
2.2.5	Other Precautions	2-8
2.3	SERVOPACK Installation	2-9
2.3.1	Orientation	2-9
2.3.2	Installation Standards	2-10
2.4	EMC Installation Conditions	2-11
2.4.1	SGDV-□□□E21A (M-III Model)	2-11
2.4.2	Other Precautions	2-12

2.1 Installation Environment and Applicable Standards

The installation environment and the applicable standards for servomotors and SERVOPACKs are described in this section.

2.1.1 Servomotor Installation Environment

- Ambient temperature: 0 to 40°C
- Ambient humidity: 80% RH or less (with no condensation)
- Altitude: 1, 000 m or less
- Vibration resistance

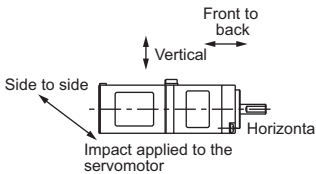

The servomotor will withstand the following vibration acceleration in three directions: vertical, side to side, and front to back.

Servomotor Model	Vibration Acceleration at Flange
SGMMV	49 m/s ²

- Shock resistance: 490 m/s² at servomotor flange
Impact occurrences: 2
- Installation site: An environment that satisfies the following conditions
 - Indoors and free of corrosive or explosive gases
 - Well-ventilated and free of dust and moisture
 - Facilitates inspection and cleaning
 - Free of high magnetic field

2.1.2 SERVOPACK Installation Environment

- Surrounding air temperature: 0 to 55°C
- Ambient humidity: 90% RH or less (with no condensation)
- Altitude: 1,000 m or less
- Vibration resistance: 4.9 m/s²
- Shock resistance: 19.6 m/s²
- Installation Precautions

- Mounting in a Control Panel

To prevent the temperature around the SERVOPACK from exceeding 55°C, take into account the size of the control panel, the layout of the SERVOPACK, and the cooling method. For details, refer to 2.3 *SERVOPACK Installation*.

- Mounting Near a Heating Unit

To prevent the temperature around the SERVOPACK from exceeding 55°C, suppress radiant heat from the heating unit and temperature rise due to convection.

- Mounting Near a Vibration Source

To prevent vibration from being transmitted to the SERVOPACK, install a vibration isolator underneath the SERVOPACK.

- Mounting to a Location Exposed to Corrosive Gas

Take measures to prevent exposure to corrosive gas. Corrosive gases will not immediately affect the SERVOPACK, but will eventually cause electronic components and contactor-related devices to malfunction.

- Other Locations

Do not mount the SERVOPACK in locations subject to high temperatures, high humidity, dripping water, cutting oil, dust, iron filings, or radiation.

<Note>

When storing the SERVOPACK with the power OFF, store it in an environment with the following temperature and humidity:

- -20 to +85°C, 90% RH or less. (with no condensation)

2.1.3 Installation Conditions for Applicable Standards

Applicable Standards	UL508C EN55011 group1 classA, EN61000-6-2, EN61800-3, EN61800-5-1
Operating Conditions	Pollution degree: 2 Protection class: IP10
Installation Conditions	UL Standard and Low Voltage Directive: Satisfy the conditions outlined in DC Power Input <i>Σ-V Series AC SERVO-PACK SGD V Safety Precautions</i> (TOBP C710829 06) EMC Directive: Certification is required after installation in the user's machine under the conditions outlined in <i>2.4 EMC Installation Conditions</i> of this manual.

2.2 Servomotor Installation

2.2.1 Orientation

Servomotors can be installed either horizontally or vertically.

2.2.2 Installation Standards

The motor rated specifications (rated output, rated torque, and rated speed) are the continuous allowable values at an ambient temperature of 40°C when servomotors are installed with heat sinks.

For more information on heat sinks, refer to *Σ-V Series Product Catalog* (KAEP S800000 42).

When a motor is mounted on a small surface, the motor temperature may rise considerably because of the limited heat radiating abilities of the surface. To restrict the temperature rise, you should either mount a heat sink or limit the electrical, thermal, and mechanical stress on the motor (derating). Refer to *Σ-V Series Product Catalog* (KAEP S800000 42) for the relation between heat sink size and derating. The data in the catalog is given only for reference, as the actual temperature rise depends on how the heat sink (motor mounting section) is fixed on the installation surface and what material is used for the motor mounting section. Always check the actual motor temperature.

If the servomotor is covered, or if a heating element is installed near the servomotor, the motor temperature may rise considerably. In this case, take following countermeasures.

- Reduce the load ratio.
- Reconsider the motor heating conditions.
- Install a cooling fan to forcedly cool the motor.

2.2.3 Connecting Servomotor to Machine

The end of the motor shaft is coated with anticorrosive paint. Thoroughly remove the paint prior to installation.

Align the shaft of the servomotor with the shaft of the machine, and then couple the shafts. Install the servomotor so that alignment accuracy falls within the following range. Vibration will damage the bearings or encoders if the shafts are not properly aligned.

Do not allow direct impact to be applied to the shafts when installing the coupling as the encoder mounted on the opposite end of the shaft may be damaged.

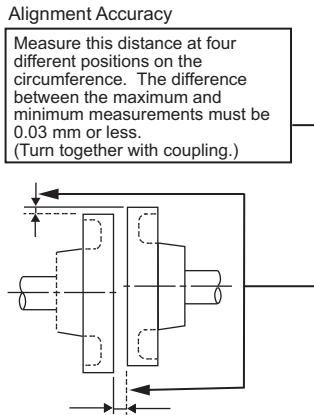

2.2.4 Protective Structure

The servomotor protective structure* is described below.

Model	Protective Structure
SGMMV-B□E	IP42
SGMMV-A□E	IP55

* Except through shaft section.

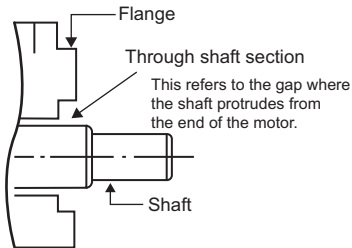

2.2.5 Other Precautions

■ Cable Stress

Make sure there are no bends or tension on the servomotor main circuit cables and encoder cables.

Be especially careful to wire encoder cables so that they are not subject to stress because the core wires are very thin at only 0.2 or 0.3 mm².

■ Connectors

Observe the following precautions:

- Make sure there is no foreign matters such as dust and metal chips in the connector before connecting.
- When the connectors are connected to the motor, be sure to connect the end of servomotor main circuit cables before connecting the encoder cable's end.
If the encoder cable's end is connected, the encoder may break because of the voltage differences between FG.
- Make sure of the pin arrangement.
- Do not apply shock to resin connectors. Otherwise, they may be damaged.
- When handling a servomotor with its cables connected, hold the servomotor or the connectors and cables will be damaged.
- Be sure not to apply stress on the connector. The connector may be damaged by stress.

■ Radial and Thrust loads

Design the mechanical system so thrust and radial loads applied to the servomotor shaft end during operation fall within the allowable ranges of each motor. Refer to *ΣV Series Product Catalog* (KAEP S800000 42) for the allowable ranges.

2.3 SERVOPACK Installation

2.3.1 Orientation

The DC power input Σ -V series SERVOPACKs are base-mounted. The SERVOPACKs must be mounted with a vertical orientation.

Firmly secure the SERVOPACK onto the mounting surface at the two locations where the mounting holes are.

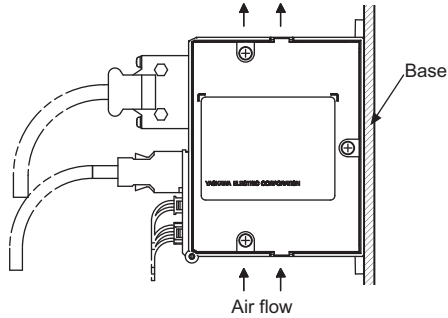

2.3.2 Installation Standards

Observe the standards for mounting SERVOPACKs in control panels, including those for the mounting SERVOPACKs side by side in one control panel as shown in the following illustration.

- **SERVOPACK Mounting Orientation**

Mount the SERVOPACK vertically to the wall, with the front panel facing out.

- **Cooling**

Refer to the following diagram and leave sufficient space for cooling by fans and natural convection.

- **Mounting SERVOPACKs Side by Side in a Control Panel**

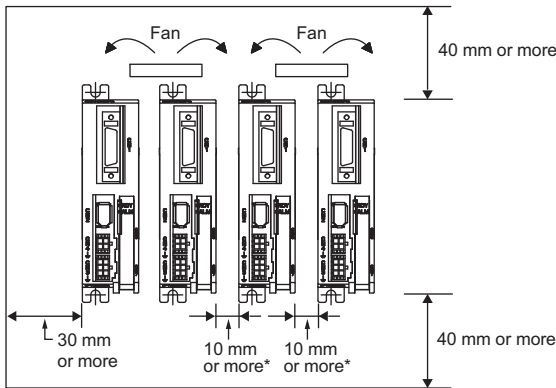

* Mounting differs with cooling method.

Leave sufficient space on each side and at the top and the bottom of each SERVOPACK. Space between SERVOPACKs differs with the cooling method as shown in the following table.

Cooling Method	Per Side	Top and Bottom
Fan*	1 mm or more	40 mm or more
Natural Convection	10 mm or more	

* When the space between SERVOPACKs is less than 10 mm, select fans that will circulate air at a wind velocity of 0.2 m/s or more when a wind gauge is installed 10 mm away from the bottom of the SERVOPACK.

- **Inside the Control Panel**

The conditions inside the control panel should be the same as the environmental conditions of the SERVOPACK. Refer to 2.1.2 *SERVOPACK Installation Environment*.

2.4 EMC Installation Conditions

This section describes the recommended installation conditions that satisfy EMC guidelines when combining a SGD_V SERVOPACK in the DC power input Σ -V series with a SGMMV servomotor in the Σ -Vmini series.

The recommended installation conditions for SERVOPACKs with MECHATROLINK-III communications are described here. For SERVOPACKs with a different interface, refer to the following installation conditions.

The following illustration shows the EMC installation conditions satisfied in test conditions prepared by Yaskawa. The actual EMC level may differ depending on the actual system's configuration, wiring, and other conditions. However, because this product is built-in, check that the following conditions are still met after being installed in the user's product.

The applicable standards are EN55011 group 1 class A, EN61800-3, and EN61000-6-2.

2.4.1 SGD_V-□□□E21A (M-III Model)

■ SGD_V-□□□E21A (□□□ = 1R7, 2R9)

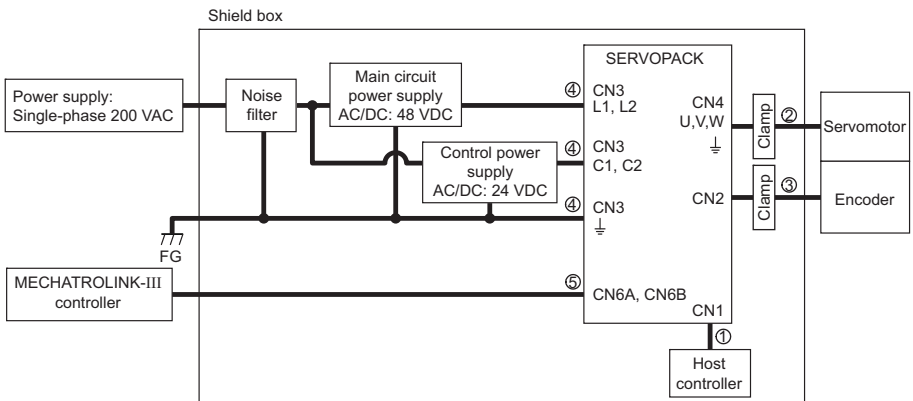

Symbol	Cable Name	Specification
①	I/O signal cable	Shield cable
②	Servomotor main circuit cable	Shield cable
③	Encoder cable	Shield cable
④	Power supply cable	Without shield cable
⑤	MECHATROLINK-III communication cable	Shield cable

2.4.2 Other Precautions

■ Recommended Noise Filter

For more information on recommended noise filters, refer to *Σ-V Series Product Catalog*. (KAEP S800000 42)

■ Fixing the Cable

Fix and ground the cable shield using a piece of conductive metal.

- Example of Cable Clamp

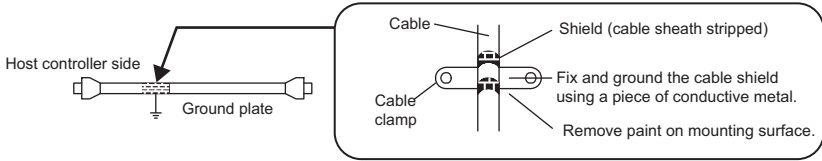

■ Shield Box

A shield box, which is a closed metallic enclosure, is effective as reinforced shielding against electromagnetic interference (EMI) from SERVOPACKs. The structure of the box should allow the main body, door, and cooling unit to be attached to the ground. The box opening should be as small as possible.

<Note>

Do not connect the digital operator and the analog monitor cable to the SERVOPACK during operations. Connect them only when the machinery is stopped during maintenance.

Wiring and Connection

This chapter describes how to set up the wiring and connections required for trial operation.

For more information on the wiring and connection, refer to the following manuals.

- DC Power Input Σ -V Series User's Manual Design and Maintenance Rotational Motor/Analog Voltage Reference and Pulse Train Reference (SIEP S800000 81)
- DC Power Input Σ -V Series User's Manual Design and Maintenance Rotational Motor/MECHATROLINK-II Communications Reference (SIEP S800000 82)
- DC Power Input Σ -V Series User's Manual Design and Maintenance Rotational Motor/MECHATROLINK-III Communications Reference (SIEP S800000 83)

3.1	Precautions for Wiring	3-2
3.2	System Configuration Diagram	3-3
3.2.1	Connecting to SGDV-□□□E□1A SERVOPACK (Analog Voltage/Pulse Train Model)	3-3
3.2.2	Connecting to SGDV-□□□E11A SERVOPACK (M-II Model)	3-4
3.2.3	Connecting to SGDV-□□□E21A SERVOPACK (M-III Model)	3-5
3.3	Main Circuit Wiring	3-6
3.3.1	Names and Functions of Main Circuit Terminals	3-6
3.3.2	SERVOPACK Main Circuit Cable	3-7
3.3.3	Typical Main Circuit Wiring Examples	3-9

3.1 Precautions for Wiring

 CAUTION

- Be sure to wire correctly and securely.
Failure to observe this caution may result in motor overrun, injury, or malfunction.
- Do not connect a commercial power supply to the U, V, or W terminals for the servomotor connection.
Failure to observe this caution may result in injury or fire.
- Do not bundle or run the servomotor main circuit cables together with the I/O signal cables or the encoder cables in the same duct. Keep the servomotor main circuit cables separated from the I/O signal cables and encoder cables by at least 30 cm.
Placing these cables too close to each other may result in malfunction.
- Use shielded twisted-pair cables or screened unshielded twisted-pair cables for I/O signal cables and the encoder cables.
- The maximum wiring length is 3 m for I/O signal cables, 50 m for servomotor main circuit cables and encoder cables, and 10 m for power supply cables.
- Voltage remains in the SERVOPACK even after the power supply is turned OFF. To prevent electric shock, do not touch the input terminals for the main circuit power supply or those for the control power supply.
Before wiring or inspections, confirm that the SERVOPACK has completely discharged.
- When using a detector or a breaker for leakage current, select the appropriate one by considering the grounding conditions and the leakage current of noise filter. For details, contact the manufacturer of the noise filter.
- Incorrect wiring or incorrect voltage application to the output circuit may cause short-circuit.
The above failures will prevent the holding brake from working, which may damage the machine or cause an accident resulting in death or injury.
- Inverting the polarity of the brake signal (/BK), i.e. positive logic, will prevent the holding brake from working in case of its signal line disconnection.
If this setting is absolutely necessary, check the operation and confirm that there are no safety problems.

3.2 System Configuration Diagram

3.2.1 Connecting to SGDV-□□□E□1A SERVOPACK (Analog Voltage/Pulse Train Model)

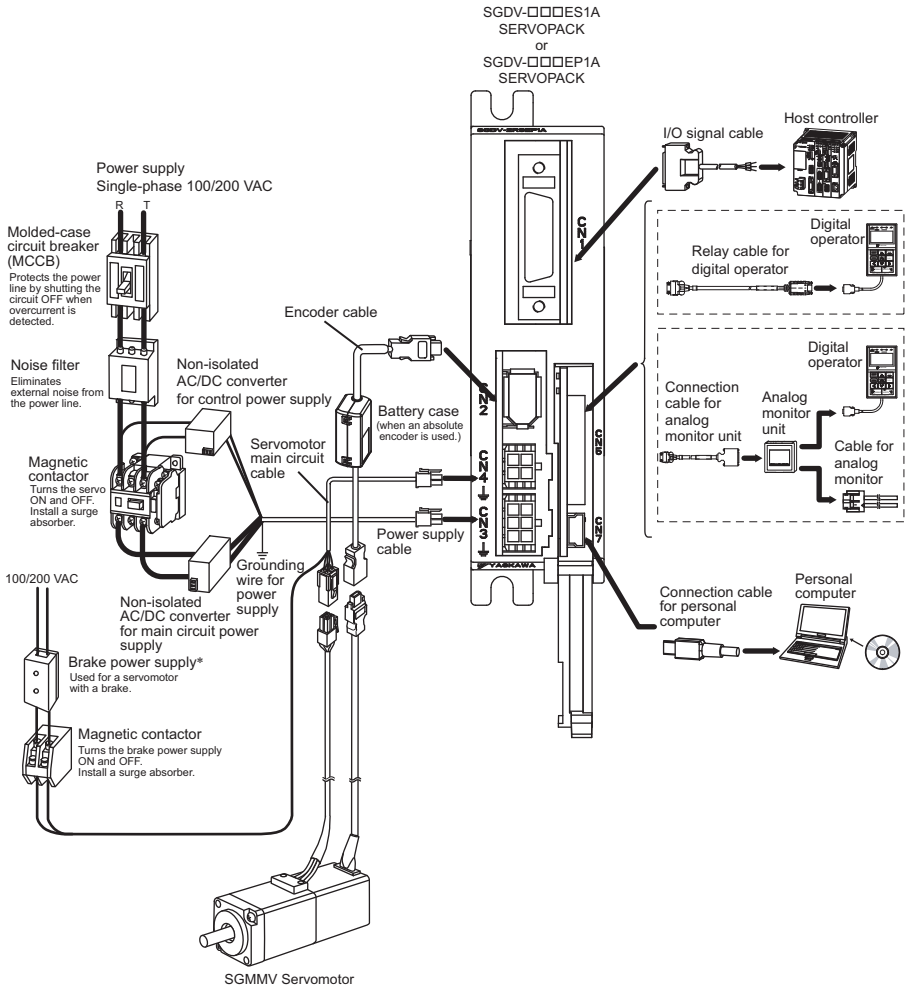

* Use a 24-VDC power supply. (Not included.)

3 Wiring and Connection

3.2.2 Connecting to SGDV-□□□E11A SERVOPACK (M-II Model)

3.2.2 Connecting to SGDV-□□□E11A SERVOPACK (M-II Model)

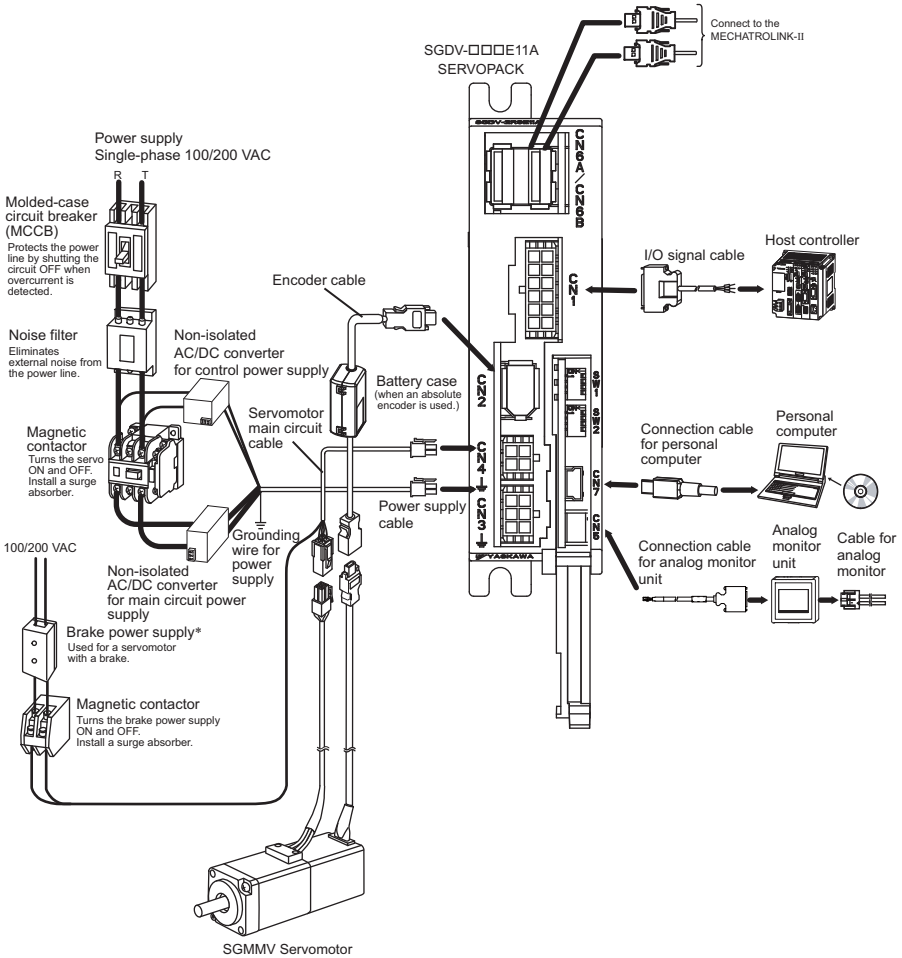

* Use a 24-VDC power supply. (Not included.)

3.2.3 Connecting to SGDV-□□□E21A SERVOPACK (M-III Model)

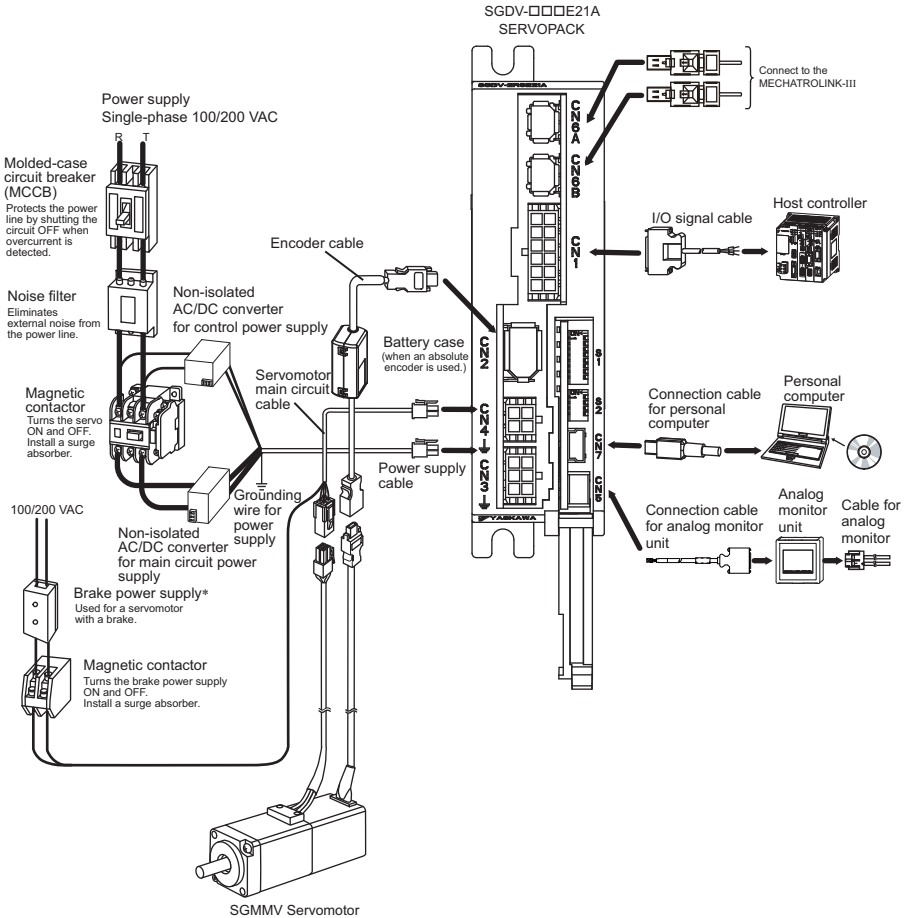

* Use a 24-VDC power supply. (Not included.)

3.3.1 Names and Functions of Main Circuit Terminals

3.3 Main Circuit Wiring

The names, specifications, and functions of the main circuit terminals required for trial operation are given below.

3.3.1 Names and Functions of Main Circuit Terminals

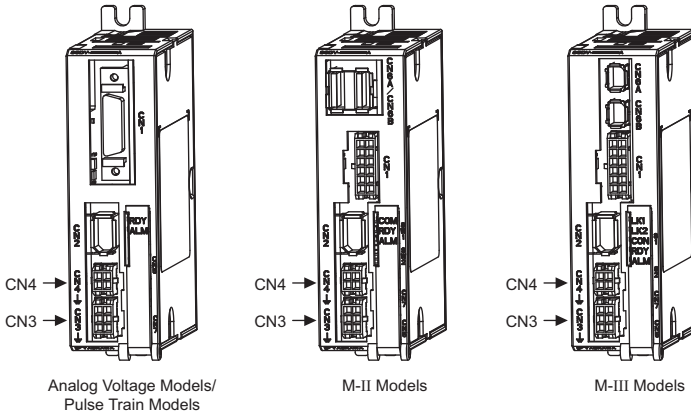

Connector	Terminal Symbols	Pin No.	Name	Description
CN3	L1	6	Main circuit input terminal (+)	24 VDC \pm 15% or 48 VDC \pm 15%
	L2	3	Main circuit input terminal (-)	
	C1	5	Control power input terminal (+)	24 VDC \pm 15%
	C2	4	Control power input terminal (-)	
	\perp	1, 2	Ground terminal	Connect to the ground terminal of the power supply.
CN4	U	1	Servomotor connection terminal (phase U)	Connect to the servomotor.
	V	2	Servomotor connection terminal (phase V)	
	W	3	Servomotor connection terminal (phase W)	
	\perp	4	Ground terminal	Connect to the ground terminal of the servomotor.

3.3.2 SERVOPACK Main Circuit Cable

Use the following cables for main circuit of the SERVOPACK. These cables are manufactured by YASKAWA Controls Co., Ltd.

Cable	Terminal Symbols	SERVOPACK Model: SGDV-	
		1R7E	2R9E
For power supply	L1, L2, C1, C2, \perp	JZSP-CF1G00-□□-E	
For servomotor main circuit	U, V, W, \perp	JZSP-CF1M00-□□-E (For servomotors without brakes) JZSP-CF1M10-□□-E (For servomotors with brakes) JZSP-CF1M20-□□-E (For servomotors without brakes, flexible type) JZSP-CF1M30-□□-E (For servomotors with brakes, flexible type)	

If you make cables by yourself, read the following items.

 IMPORTANT	<ul style="list-style-type: none"> • Wire sizes are selected for three cables per bundle at 40°C surrounding air temperature with the rated current. • Use the withstand voltage wires (for 100 V or more) • Use the wires whose outside diameter of insulator is 1.85 mm or less. • If cables are bundled in PVC or metal ducts, take into account the reduction of the allowable current. • Use a heat-resistant wire under high surrounding air or panel temperatures. • The length of cables for power supply is 10 m max., and the length of cables for servomotor main circuit is 50 m max.
---	---

Cable	SERVOPACK Model: SGDV-		Remarks	
	1R7E	2R9E		
CN3 for power supply	Connector	43025-0600*		6 poles
	Contact	43030-0001*		—
	For main circuit power supply (L1, L2, \perp)	UL1007, AWG20		Rated voltage 300 V, Rated temperature 80°C
	For control circuit power supply (C1, C2, \perp)	UL1007, AWG20		Rated voltage 300 V, Rated temperature 80°C

* Made by Molex Japan Co., Ltd.

3.3.2 SERVOPACK Main Circuit Cable

(cont'd)

Cable		SERVOPACK Model: SGD V-		Remarks
		1R7E	2R9E	
CN4 for servo-motor main circuit	Connector (SERVOPACK side)	43025-0400*		4 poles
	Contact (SERVOPACK side)	43030-0001*		—
	Connector (servomotor side, without brake)	43020-0401*		4 poles
	Connector (servomotor side, with brake)	43020-0601*		6 poles
	Contact (servomotor side)	43031-0001*		—
	Power line for servo-motor main circuit (U, V, W, brake power supply, $\underline{\underline{0}}$)	UL1007, AWG20		Rated voltage 300 V, Rated temperature 80°C

* Made by Molex Japan Co., Ltd.

3.3.3 Typical Main Circuit Wiring Examples



IMPORTANT

- Use a molded-case circuit breaker (1QF) or fuse to protect the servo system.
Always use a molded-case circuit breaker (1QF) or fuse to protect the servo system from accidents involving different power system voltages or other accidents.
- Install a ground fault detector.
The SERVOPACK does not have a built-in protective circuit for grounding.
To configure a safer system, install a ground fault detector against overloads and short-circuiting, or install a ground fault detector combined with a molded-case circuit breaker.
- Do not frequently turn power ON and OFF.
 - Frequently turning power ON and OFF causes elements inside the SERVOPACK to deteriorate. Do not use the servo drive with an application that requires frequently turning power ON and OFF.
 - After the actual operation starts, the allowable interval for turning power ON and OFF is one hour or longer.

The following wiring examples show the DC Power Input Σ -V Series SGD_V SERVOPACK (Analog voltage reference model).

■ SGD_V-□□□ES1A (□□□ = 1R7, 2R9)

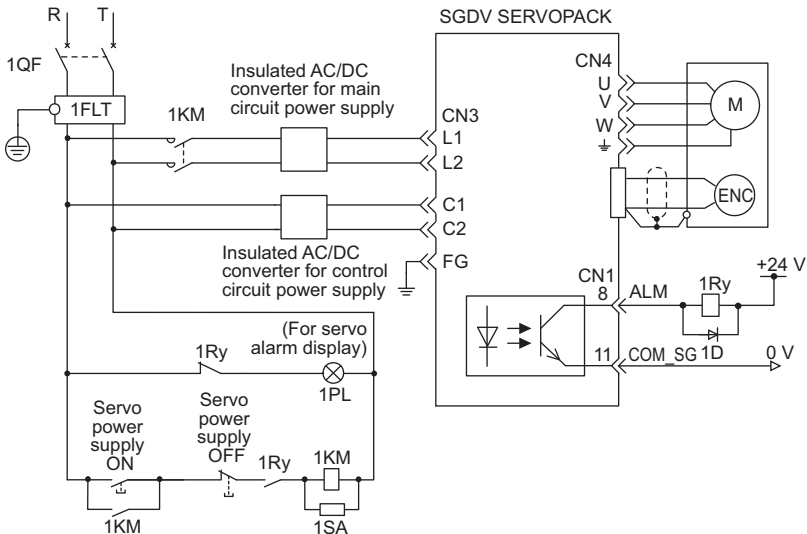

- 1QF : Molded-case circuit breaker
- 1FLT : Noise filter
- 1KM : Magnetic contactor
(for main power supply)
- 1Ry : Relay
- 1PL : Indicator lamp
- 1SA : Surge absorber
- 1D : Flywheel diode

3.3.3 Typical Main Circuit Wiring Examples

■ Precautions When Using More Than One SERVOPACK

This section shows an example of the wiring when more than one SERVOPACK is used and the precautions.

• Wiring Example (Analog model)

The alarm output (ALM) terminals in each SERVOPACK individually operate different alarm detection relays: 1Ry, 2Ry, and 3Ry respectively.

When the alarm occurs, the ALM output signal transistor is turned OFF.

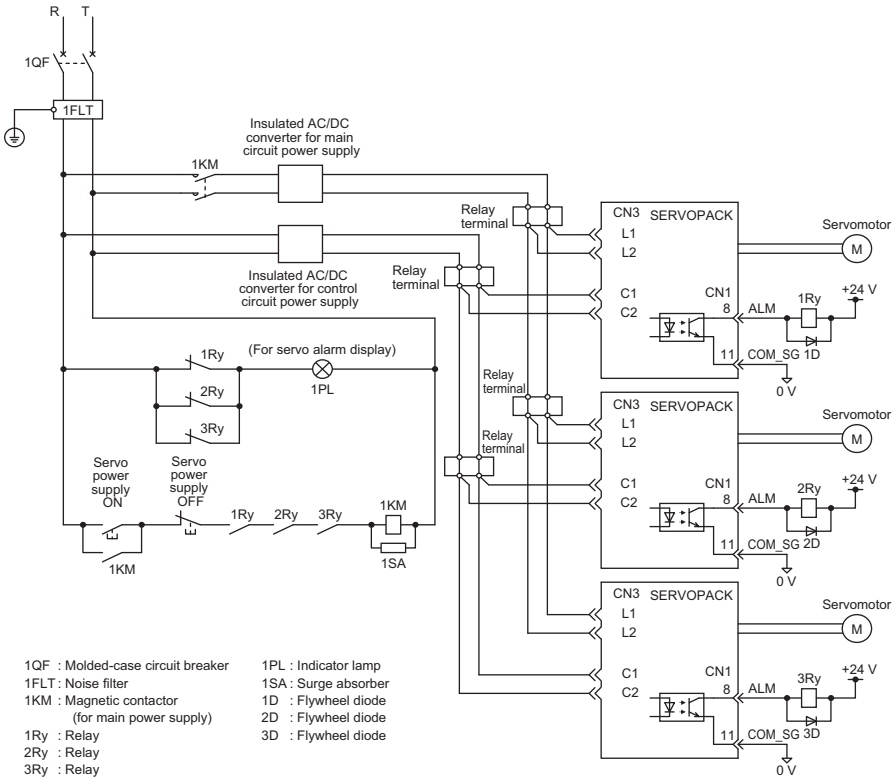



IMPORTANT

In DC power input Σ -V Series SERVOPACKS, all ground terminals for the four sequence output signals are named COM_SG. Therefore, do not connect the ALM output signal of multiple SERVOPACKS in series.

Trial Operation (Checking Servomotor Operation)

This chapter describes how to perform trial operation.

4.1 Outline	4-2
4.2 Inspection and Checking before Trial Operation	4-3
4.3 JOG Operation Using a Digital Operator	4-6
4.4 JOG Operation Using SigmaWin+	4-9

4.1 Outline

The trial operation described here is a JOG operation for servomotors not connected to machinery (without a load). The purpose of this trial operation is to check whether the SERVOPACK and servomotor are properly connected and whether the servomotor is operating normally.

To conduct trial operation executed from the host controller for the servomotor without load, or for the servomotor connected to the machine, refer to the following manuals.

- DC Power Input Σ -V Series User's Manual Design and Maintenance Rotational Motor/Analog Voltage Reference and Pulse Train Reference (SIEP S800000 81)
- DC Power Input Σ -V Series User's Manual Design and Maintenance Rotational Motor/MECHATROLINK-II Communications Reference (SIEP S800000 82)
- DC Power Input Σ -V Series User's Manual Design and Maintenance Rotational Motor/MECHATROLINK-III Communications Reference (SIEP S800000 83)

 CAUTION
<ul style="list-style-type: none">• Conduct trial operation on the servomotor alone with the motor shaft disconnected from the machine to avoid any unexpected accidents. If it is unavoidable to perform trial operation while connected to a machine, then always make sure that an emergency stop can be immediately executed.

4.2 Inspection and Checking before Trial Operation

To ensure safe and correct trial operation, inspect and check the following items before starting trial operation.

■ Servomotors

Inspect and check the following items, and take appropriate measures before performing trial operation if any problem exists.

- Are all wiring and connections correct?
- Are all nuts and bolts securely tightened?
- If the servomotor has a brake, is the brake released beforehand? To release the brake, apply the specified voltage (24 VDC). The following diagram shows an example of the circuit wiring needed to release the holding brake before a trial operation.

An Example of Wiring for Circuits

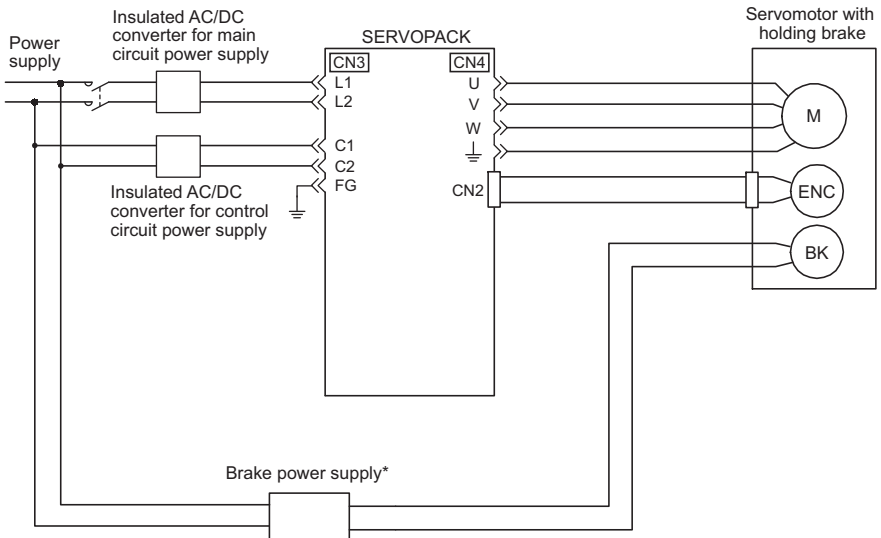

* A 24-VDC power supply for the brake is not included.

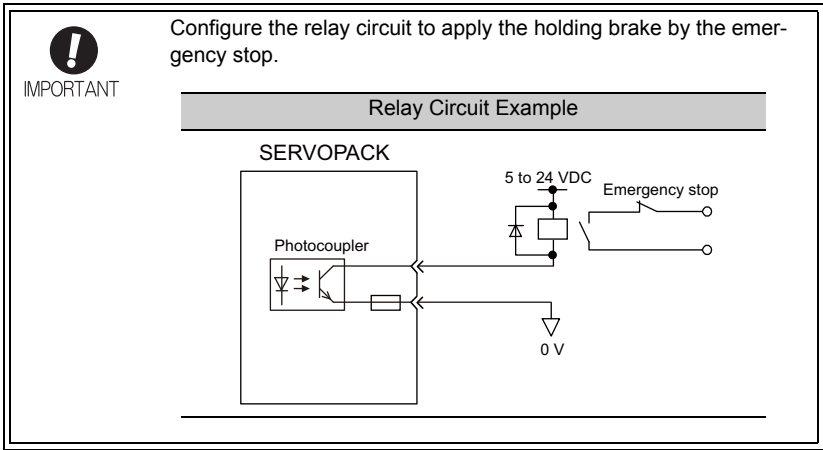

■ SERVOPACKs

Inspect and check the following items, and take appropriate measures before performing trial operation if any problem exists.

- Are all installation, wiring and connections correct?
- Is the correct power supply voltage being supplied to the SERVOPACK?

■ Installing the Servomotor and SERVOPACK

Install the servomotor and SERVOPACK according to the installation conditions.

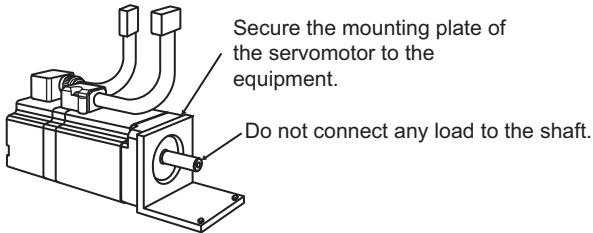

<Note>

- Be sure to secure the servomotor to the equipment, or the servomotor may turn over when it starts rotating.
- Do not connect anything to the servomotor shaft.

■ Checking the Main Circuit Power Supply, Servomotor, and Encoder Wiring

Once again, check the main circuit power supply, servomotor, and encoder wiring that was described in *Chapter 3 Wiring and Connection*.

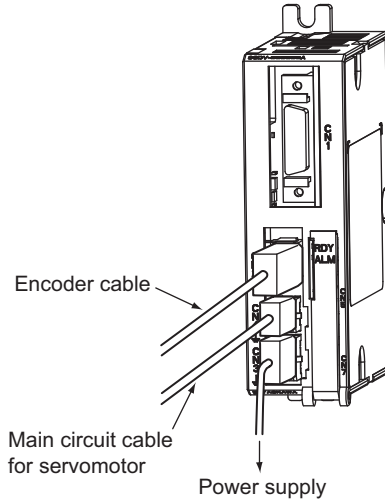

Note: Do not connect the I/O signal cable to the CN1 connector in trial operations.

4.3 JOG Operation Using a Digital Operator

This section describes the procedure for executing a JOG operation using a digital operator. The following illustration shows how to connect the digital operator.

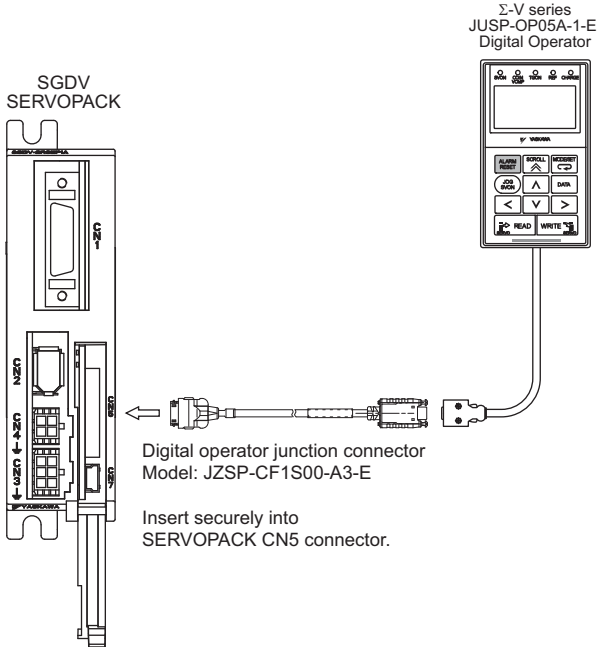

The digital operator can be connected or removed while the SERVOPACK power is ON.















IMPORTANT

- The digital operator is available for both SERVOPACKs with analog voltage reference and SERVOPACKs with pulse train reference.
- The tuning-less function is by default set enabled. When the tuning-less function is enabled, the gain may be so increased to cause vibration during no-load operation. If vibration occurs, disable the tuning-less function by setting the parameter Pn170.0 to 0.



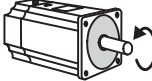
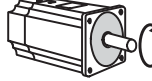

Step	Display after operation	Keys	Operation
1	<pre> BB -PRM/MON- Un000= 00000 Un002= 00000 Un008= 0000000000 Un00D= 0000000000 </pre>		Turn ON the power to the SERVOPACK. A message saying that the file list is being loaded will appear and then the parameter/monitor mode will appear.

(cont'd)

Step	Display after operation	Keys	Operation
2	<pre> BB - FUNCTION - Fn000:Alm History Fn002:JOG Fn003:Z-Search Fn004:Program JOG </pre>		<p>Press the  Key to view the main menu of the Utility Function mode.</p> <p>Press the  Key or  Key to select Fn002.</p>
3	<pre> BB - JOG - Pn304= 00500 Un000= 00000 Un002= 00000 Un00D= 000000000 </pre>		<p>Press the  Key.</p> <p>The display changes to the execution display of Fn002.</p>
4	<pre> RUN - JOG - Pn304= 00500 Un000= 00000 Un002= 00000 Un00D= 000000000 </pre>		<p>Press the  Key. "RUN" is displayed as the status, and the servomotor power turns ON.</p>
5	<pre> RUN - JOG - Pn304= 00500 Un000= 00000 Un002= 00000 Un00D= 000000000 </pre>		<p>Press the  Key to rotate the servomotor in the forward direction and press the  Key to rotate it in reverse. The servomotor will operate while the key is being pressed. (The factory setting is 500 min⁻¹.)</p> <div style="display: flex; justify-content: space-around; align-items: center;"> <div style="text-align: center;">  <p>Forward rotation</p> </div> <div style="text-align: center;">  <p>Reverse rotation</p> </div> </div> <p>Confirm that the servomotor operation is correct. At the same time, carefully inspect the servomotor's condition and check the following points in particular. If a problem is found, correct it.</p> <ul style="list-style-type: none"> • Is there any unusual vibration? • Are there any unusual sound? • Is the temperature rising unusually high?
6	<pre> BB - JOG - Pn304= 00500 Un000= 00000 Un002= 00000 Un00D= 000000000 </pre>		<p>After confirming that the servomotor is running correctly, press the  Key. "BB" is displayed as the status, and the servomotor power turns OFF.</p>

Trial Operation (Checking Servomotor Operation)

(cont'd)

Step	Display after operation	Keys	Operation
7	<pre> BB -FUNCTION- Fn000:Alm History Fn002:JOG Fn003:Z-Search Fn004:Program JOG </pre>		Press the  Key to return to the main menu of the Utility Function mode.
8	<pre> BB -PRM/MON- Un000= 00000 Un002= 00000 Un008= 0000000000 Un00D= 0000000000 </pre>		Press the  Key twice to return to the initial display (step 1).

■ Alarm Display

An alarm is automatically displayed if a problem occurs for some reason. Check the alarm using the user’s manual for the corresponding SERVOPACK (refer to ■ *Manu- als Related to the DC Power Input Σ-V Series* on page iv) and apply the appropriate measures.

```

A. 710          -ALARM-
A. 710 00001207196
1: 720 00000032651
2: 511 00000009043
3: ---
                    
```

■ Error Display

The following messages will be displayed if a communications error occurs between the SERVOPACK and the digital operator due to a connection problem such as poor connector contact. Check the connections and turn the power ON again. If the problem still persists, the digital operator or SERVOPACK must be replaced.

```

          CPF00
          COM-ERR(OP&SV)
                    
```

```

          CPF01
          COM-ERR(OP&SV)
                    
```

4.4 JOG Operation Using SigmaWin+



This section describes the procedure for executing a JOG operation using SigmaWin+.





In the following example, test-run procedures are explained using the JOG operation window of Test Run on the main menu of SigmaWin+.

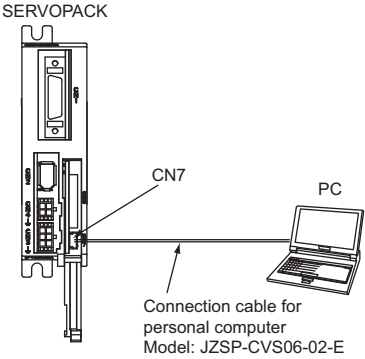

IMPORTANT

The tuning-less function is by default set enabled. When the tuning-less function is enabled, the gain may be so increased to cause vibration during no-load operation. If vibration occurs, disable the tuning-less function by setting the parameter Pn170.0 to 0.

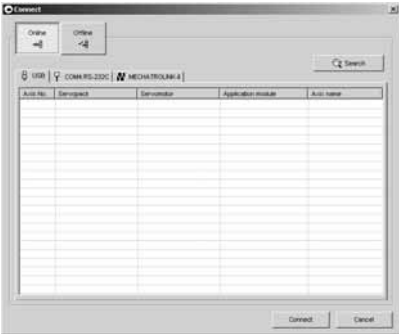

Step	Operation	Display
1	<ul style="list-style-type: none"> Connect a computer. Use a connection cable to connect a SERVOPACK to a computer which has SigmaWin+ installed. 	
2	<ul style="list-style-type: none"> Start SigmaWin+ and open the main window. (1) Turn ON the SERVOPACK. (2) Turn ON the computer. (3) Double click the YE_Applications folder on the desktop. 	 YE_Applications

Step	Operation	Display
<p>2 (cont'd)</p>	<p>(4) Double click the SigmaWin+ icon to display the SigmaWin+ startup screen.</p> <p>(5) Once SigmaWin+ is started, the connection window is displayed.</p> <p>Note:  is used for operation with no SERVOPACK connected.</p> <p>Click  to search for the connected SERVOPACK.</p>	<div data-bbox="591 231 756 363">  <p>SigmaWin+ English Edition</p> </div> <div data-bbox="591 383 983 646">  <p>Startup Screen</p> </div> <div data-bbox="588 689 987 1024">  <p>Connection Window</p> </div>

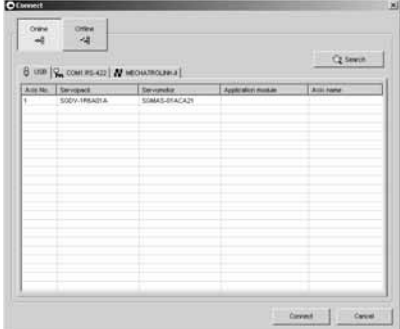
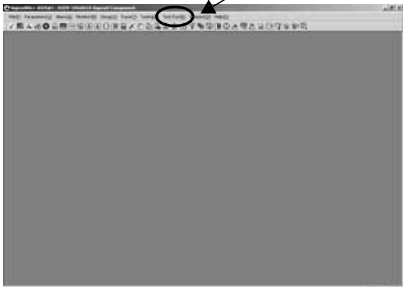

(cont'd)



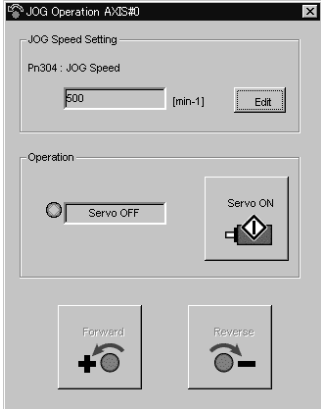

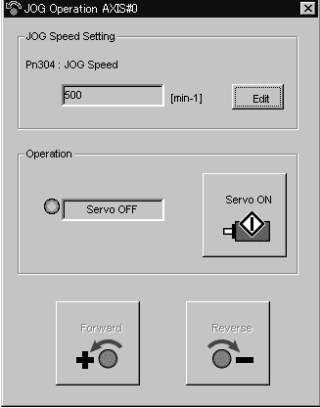

Step	Operation	Display
<p>2 (cont'd)</p>	<p>(6) Search Condition Setting window is open. Select Σ-V(<input checked="" type="checkbox"/> ΣV), and click <input .<br="" type="button" value="Search"/> A dialog box will open first to tell you a search has started, and then the search result will be shown in the connection window. Note: If the message, “Servopack not found” is displayed, refer to 2.2 <i>Selecting a SERVOPACK</i> of SigmaWin+ English Edition Online Manual (YE_Applications -> Manual).</p> <p>(7) Select the SERVOPACK to be connected. Click <input (place="" .="" and="" be="" click="" connected,="" cursor="" it.)<br="" on="" over="" servopack="" the="" then="" to="" type="button" value="Connect"/> The main window of SigmaWin+ will then open.</p>	 <p style="text-align: center;">Search Condition Setting Window</p> 
<p>3</p>	<ul style="list-style-type: none"> Run test operation. <p>(1) Select Test Run first, and then select Jog (J) from the menu on the main window.</p>	<p style="text-align: center;">Test Run (R) → Jog (J)</p>  <p style="text-align: center;">Main Window</p>

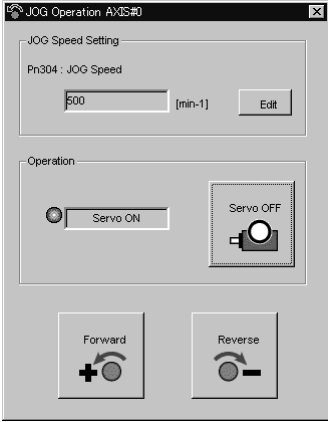
Trial Operation (Checking Servomotor Operation)

Step	Operation	Display
<p>3 (cont'd)</p>	<p>(2) Warnings for the JOG operation window will be displayed. Read them and click  .</p>	 <p>Warnings for the JOG Operation Window</p>
	<p>(3) The JOG operation window is open.</p>	 <p>JOG Operation Window</p>

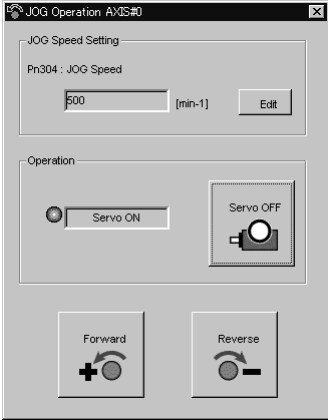
(cont'd)

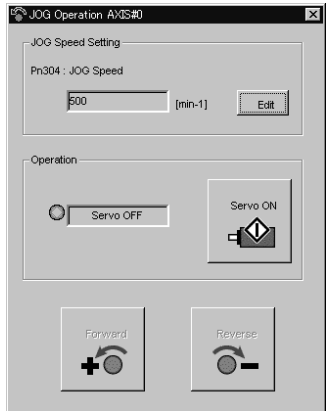
Step	Operation	Display
4	<ul style="list-style-type: none"> Set the JOG speed The motor speed is set to 500 [min⁻¹]. Click  if you need to change it. 	
5	<ul style="list-style-type: none"> Servo ON Click  . The display changes from Servo OFF to Servo ON and is lit in green.	

Step	Operation	Display
6	<ul style="list-style-type: none"> Start JOG operation. <p>When you click  the servomotor will rotate in the forward direction. When you click  it will rotate in reverse.</p> <p>Confirm that the servomotor operation is correct. At the same time, carefully inspect the servomotor's condition and check the following points in particular. If a problem is found, correct it.</p> <ul style="list-style-type: none"> Is there any unusual vibration? Is there any unusual sound? Is the temperature rising unusually high? 	
7	<ul style="list-style-type: none"> Servo OFF <p>Click  . (Screen display will return to the display shown at step 4.)</p>	
8	<ul style="list-style-type: none"> Terminate JOG operation. <p>Click  to end JOG operation.</p>	You will return to the main window.

Refer to the online manual for SigmaWin+ for details. Follow the steps below to view the online manual.

<How to view the online manual>

1. Turn ON the computer.
2. Open the YE_Applications folder.
3. Open the Manual folder.
4. Open SigmaWin+ English Edition Online Manual.

Revision History

The revision dates and numbers of the revised manuals are given at the bottom of the back cover.

MANUAL NO. SIEP S800000 80A

Published in Japan November 2011 11-11

└ Date of
publication

└ Date of original publication

Date of Publication	Rev. No.	Section	Revised Contents
November 2011	—	—	First edition

AC Servo Drives

DC Power Input Σ -V Series

USER'S MANUAL

Setup

Rotational Motor

IRUMA BUSINESS CENTER (SOLUTION CENTER)

480, Kamifujisawa, Iruma, Saitama 358-8555, Japan
Phone 81-4-2962-5151 Fax 81-4-2962-6138

YASKAWA AMERICA, INC.

2121 Norman Drive South, Waukegan, IL 60085, U.S.A.
Phone (800) YASKAWA (800-927-5292) or 1-847-887-7000 Fax 1-847-887-7310

YASKAWA ELÉTRICO DO BRASIL LTDA.

Avenida Fagundes Filho, 620 São Paulo-SP CEP 04304-000, Brazil
Phone 55-11-3585-1100 Fax 55-11-5581-8795

YASKAWA EUROPE GmbH

Hauptstraße 185, Eschborn 65760, Germany
Phone 49-6196-569-300 Fax 49-6196-569-398

YASKAWA ELECTRIC UK LTD.

1 Hunt Hill Orchardton Woods Cumbernauld, G68 9LF, United Kingdom
Phone 44-1236-735000 Fax 44-1236-458182

YASKAWA ELECTRIC KOREA CORPORATION

7F, Doore Bldg. 24, Yeoido-dong, Yeoungdongpo-gu, Seoul 150-877, Korea
Phone 82-2-784-7844 Fax 82-2-784-8495

YASKAWA ELECTRIC (SINGAPORE) PTE. LTD.

151 Lorong Chuan, #04-01, New Tech Park 556741, Singapore
Phone 65-6282-3003 Fax 65-6289-3003

YASKAWA ELECTRIC (SHANGHAI) CO., LTD.

No.18 Xizang Zhong Road, 17F, Harbour Ring Plaza Shanghai 200001, China
Phone 86-21-5385-2200 Fax 86-21-5385-3299

YASKAWA ELECTRIC (SHANGHAI) CO., LTD. BEIJING OFFICE

Room 1011, Tower W3 Oriental Plaza, No.1 East Chang An Ave.,
Dong Cheng District, Beijing 100738, China
Phone 86-10-8518-4086 Fax 86-10-8518-4082

YASKAWA ELECTRIC TAIWAN CORPORATION

9F, 16, Nanking E. Rd., Sec. 3, Taipei 104, Taiwan
Phone 886-2-2502-5003 Fax 886-2-2505-1280



YASKAWA ELECTRIC CORPORATION

In the event that the end user of this product is to be the military and said product is to be employed in any weapons systems or the manufacture thereof, the export will fall under the relevant regulations as stipulated in the Foreign Exchange and Foreign Trade Regulations. Therefore, be sure to follow all procedures and submit all relevant documentation according to any and all rules, regulations and laws that may apply.

Specifications are subject to change without notice for ongoing product modifications and improvements.

© 2007-2011 YASKAWA ELECTRIC CORPORATION. All rights reserved.

MANUAL NO. SIEP S800000 80A

Published in Japan November 2011 11-11
10-10-4

Original instructions