

MITSUBISHI

D/A Converter Unit for A0J2 Type A0J2-62DA

User's Manual

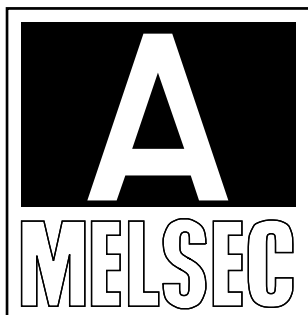
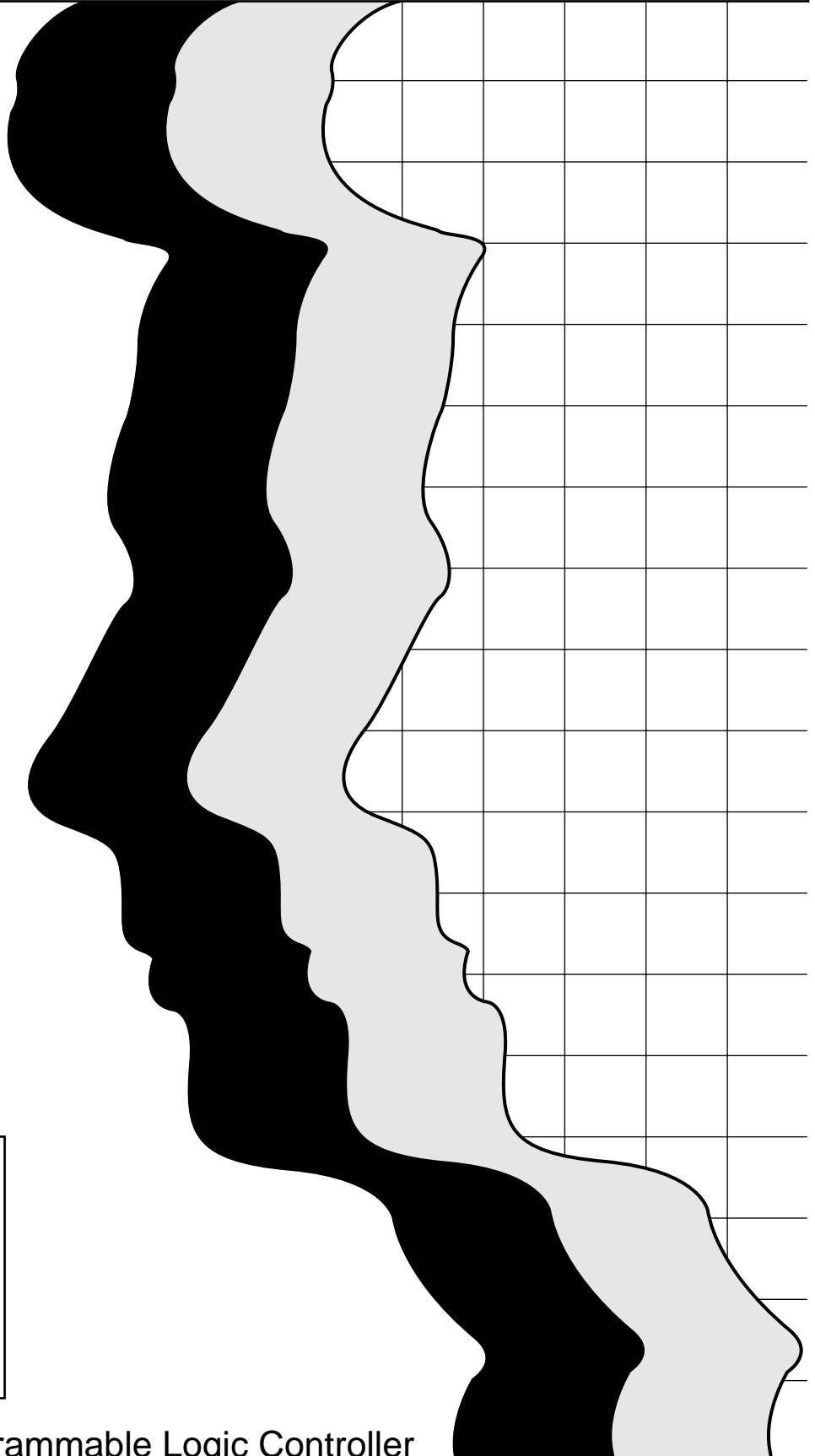

Mitsubishi Programmable Logic Controller

● SAFETY PRECAUTIONS ●

(Read these precautions before using.)

When using Mitsubishi equipment, thoroughly read this manual and the associated manuals introduced in this manual. Also pay careful attention to safety and handle the module properly.

These precautions apply only to Mitsubishi equipment. Refer to the CPU module user's manual for a description of the PLC system safety precautions.

These ● **SAFETY PRECAUTIONS** ● classify the safety precautions into two categories: "DANGER" and "CAUTION".



DANGER

Procedures which may lead to a dangerous condition and cause death or serious injury if not carried out properly.



CAUTION

Procedures which may lead to a dangerous condition and cause superficial to medium injury, or physical damage only, if not carried out properly.

Depending on circumstances, procedures indicated by  **CAUTION** may also be linked to serious results.

In many case, it is important to follow the directions for usage.

Store this manual in a safe place so that you can take it out and read it whenever necessary.

Always forward it to the end user.

[Cautions on Design]

DANGER

- Provide a safety circuit outside the PLC so that the entire system will operate safely even when an external power supply fault or PLC fault occurs.
Failure to observe this could lead to erroneous outputs, erroneous operation or accidents.
 - (1) The analog output state will differ according to the setting state of the various functions for controlling the analog output.
Take special care when making the settings.
Refer to section 2.3.2 for details on the analog output state.
 - (2) If there is a fault in the output element or the internal circuit, correct outputs may not be possible or erroneous outputs may be made.
Provide a circuit to externally monitor output signals that could lead to major faults.

CAUTION

- Do not bundle the control wire and the communication cable with the main circuit or power line or keep them close to one another.
Keep the control wire and the communication cable at least 100 mm (3.94 inch) away from the main circuit or power line: otherwise, noise or malfunctions will occur.
- At the time of power ON or OFF, a voltage or current may be instantaneously output from output terminals.
Therefore, ensure stable analog outputs before starting the control.

[Cautions on Installation]

CAUTION

- Use the PLC in the environment specified in the General Specifications section in this manual. Using it in an environment which does not meet the general specifications could cause electric shock, fire or malfunctions, and damage or deterioration of the module.
- Connect the I/O cable and extension cable securely with the catch on the unit's connector. If the cable is not connected securely, malfunctions may occur due to faulty contact.
- Mount the unit to the panel securely, with screws, for example. A unit that is not fixed securely could fall, or cause malfunction, trouble.
- Tighten the screw in the specified torque range. Undertightening can cause a drop, short circuit or malfunction. Overtightening can cause a drop, short circuit or malfunction due to damage to the screw or unit.

[Cautions on Wiring]

CAUTION

- If noise or ripple is generated in the external wiring, connect a 0.1 to 0.47 μ FWV capacitor to the input terminal on the external unit. Ground this module's FG and power supply unit FG at the same time.
- Use applicable solderless terminals and tighten them with the specified torque. If any solderless spade terminal is used, it may be disconnected when the terminal screw comes loose, resulting in failure.
- Before connecting wires to the PLC, check the rated voltage and the terminal arrangement. Connecting power of a different voltage or wiring incorrectly will result in fire or failure.
- Tighten the terminal screws to the specified torque. Loose terminal screws will cause a short, fire or malfunctions.
- Overtightening can cause a drop, short circuit or malfunction due to damage to the screw or unit.
- Take all possible measures to prevent chips or wire scraps from entering the module. Entry of foreign material will cause fire, failure of malfunctions.

[Cautions on Start-Up and Maintenance]

DANGER

- Do not touch the terminals while they are live. This will cause malfunctions.
- Switch all phases of the external power supply off when cleaning the module or tightening the terminal screws. Not doing so can cause a module failure or malfunction. Undertightening can cause a drop, short circuit or malfunction. Overtightening can cause a drop, short circuit or malfunction due to damage to the screw or module.

[Cautions on Installation]

CAUTION

- Do not disassemble or tamper with the module.
This will cause failure, malfunctions, injuries or fire.
- Switch all phases of the external power supply off when installing or removing the I/O cables and extension cables.
- Always make sure to touch the grounded metal to discharge the electricity charged in the body, etc., before touching the module.
Failure to do so may cause a failure or malfunctions of the module.

[Cautions on Disposal]

CAUTION

- Dispose of the module as industrial waste.

REVISIONS

※The manual number is given on the bottom right of the top cover.

Print Date	*Manual Number	Revision
Nov., 1986	IB (NA) 66093-A	First edition
Nov., 1988	IB (NA) 66093-B	<div style="border: 1px solid black; padding: 2px; display: inline-block;">Correction</div> Page 2-1, 2-6, 6-2, 7-1
Jul., 1997	IB (NA) 66093-C	<div style="border: 1px solid black; padding: 2px; display: inline-block;">Addition</div> SAFETY PRECAUTIONS <div style="border: 1px solid black; padding: 2px; display: inline-block;">Part Addition</div> Section 2.3.1, 6.2.4 <div style="border: 1px solid black; padding: 2px; display: inline-block;">Correction</div> Chapter 1, 2, Section 3.1, 3.2.1, 3.2.2, 3.2.3, 3.2.4, Chapter 4, Section 6.2, Chapter 7
May, 2000	IB (NA) 66093-D	<div style="border: 1px solid black; padding: 2px; display: inline-block;">Addition</div> WARRANTY <div style="border: 1px solid black; padding: 2px; display: inline-block;">Part Addition</div> Section 2.2.2 <div style="border: 1px solid black; padding: 2px; display: inline-block;">Correction</div> SAFETY PRECAUTIONS , Section 2.2.1, 3.1
July, 2003	IB (NA) 66093-E	<div style="border: 1px solid black; padding: 2px; display: inline-block;">Correction</div> SAFETY PRECAUTIONS , Chapter 1, Section 4.2
Mar, 2006	IB (NA) 66093-F	<div style="border: 1px solid black; padding: 2px; display: inline-block;">Correction</div> SAFETY PRECAUTIONS

INTRODUCTION

Thank you for choosing the Mitsubishi MELSEC-A Series of General Purpose Programmable Controllers. Please read this manual carefully so that the equipment is used to its optimum. A copy of this manual should be forwarded to the end User.

1. GENERAL DESCRIPTION	1-1 ~ 1-2
2. SPECIFICATIONS	2-1 ~ 2-11
2.1 General Specifications	2-1
2.2 Performance Specifications	2-2
2.2.1 Performance specifications	2-2
2.2.2 I/O conversion characteristics	2-3
2.3 I/O List with Respect to Programmable Controller CPU	2-8
2.3.1 I/O list	2-8
2.3.2 I/O signals and analog output	2-9
2.4 Buffer Memory	2-10
2.4.1 Assignment of buffer memory	2-10
2.4.2 Contents and data configuration of buffer memory	2-10
3. HANDLING	3-1 ~ 3-5
3.1 Handling Instructions	3-1
3.2 Nomenclature, Settings and Checking	3-2
3.2.1 Nomenclature	3-2
3.2.2 Unit number setting	3-3
3.2.3 Internal power supply (5 VDC) setting	3-4
3.2.4 Internal power supply (5 VDC) checking	3-5
4. WIRING	4-1
4.1 Wiring Instructions	4-1
4.2 Unit Connection Example	4-1
5. CONCEPT OF THE 62DA I/O NUMBERS IN A0J2 SYSTEM	5-1
5.1 I/O Number Assignment and Concept	5-1
6. PROGRAMMING	6-1 ~ 6-4
6.1 Initial Setting	6-1
6.2 Programs	6-2
6.2.1 Basic programs for read and write	6-2
6.2.2 Write of digital value	6-3
6.2.3 Reset of check codes	6-3
6.2.4 Application circuit examples	6-4

7. TEST OPERATION AND ADJUSTMENTS	7-1 ~ 7-4
7.1 Offset/Gain Setting	7-1
7.2 Checking Points before Start of Operation	7-4
8. TROUBLESHOOTING	8-1 ~ 8-4
8.1 Troubleshooting Flow Chart	8-1
8.2 Flow Chart Used When "RUN" LED Has Flickered or Turned Off.....	8-2
8.3 Flow Chart Used When Analog Output Is Not Provided Properly	8-3
APPENDIX	APP-1
1. EXTERNAL DIMENSIONS	APP-1

1. GENERAL DESCRIPTION

This User's Manual describes the specifications, handling, programming procedures, etc. of the AOJ2-62DA digital-analog converter unit (hereinafter referred to as "62DA") which is used in combination with the AOJ2CPU unit.

The general description of each chapter is as follows:

Chapter 2 Specifications

Describes the specifications and functions.

Chapter 3 Handling

Describes the handling instructions, nomenclature, and settings.

Chapter 4 Wiring

Describes the wiring.

Chapter 5 Concept of the 62DA I/O Numbers in AOJ2 System

Gives the 62DA I/O number concept and precautions.

Chapter 6 Programming

Gives the programming procedures and application circuits.

Chapter 7 Test Operation and Adjustments

Describes offset/gain setting and items to be checked before test operation is initiated.

Chapter 8 Troubleshooting

Describes the causes and remedies of the problems that may occur with programs and hardware.

Appendix

62DA external dimensions.

Refer to the User's Manual, Programming Manual, Data Link Reference Manual for each CPU module as required when using 62DA.

POINT

In this manual, the I/O assignment numbers of the 62DA assume that the unit number is set to 0. If the unit number is set to other than 0, determine the 62DA assignment number according to the I/O assignment procedure in the Programming Manual.

2. SPECIFICATIONS



2. SPECIFICATIONS

2.1 General Specifications

Table 2.1 shows the general specifications of the 62DA.

Item	Specifications				
Operating ambient temperature	0 to 55°C				
Storage ambient temperature	-20 to 75°C				
Operating ambient humidity	10 to 90%RH, no condensation				
Storage ambient humidity	10 to 90%RH, no condensation				
Vibration resistance	Conforms to *JIS C 0911	Frequency	Acceleration	Amplitude	Sweep Count
		10 to 55Hz	—	0.075mm (0.003 in)	10 times **(1 octave/minute)
		55 to 150Hz	9.8m/s ² (1g)	—	
Shock resistance	Conforms to JIS C 0912 [98m/s ² (10g) x 3 times in 3 directions]				
Noise durability	By noise simulator 1500 Vpp noise voltage, 1 μs noise width and 25 to 60 Hz noise frequency				
Dielectric withstand voltage	500 VAC for 1 minute across batch of analog output terminals and ground				
	250 VAC for 1 minute across batch of 24 VDC input terminals and ground				
Insulation resistance	5 MΩ or larger by 500 VDC insulation resistance tester across batch of analog output terminals and ground				
	5 MΩ or larger by 250 VDC insulation resistance tester across batch of 24 VDC input terminals and ground				
Operating ambience	To be free from corrosive gases. Dust should be minimal.				
Cooling method	Self-cooling				

*JIS = Japanese Industrial Standard

Table 2.1 General Specifications

REMARK

One octave marked ** indicates a change from the initial frequency to double or half frequency. For example, any of the changes from 10 Hz to 20 Hz, from 20 Hz to 40 Hz, from 40 Hz to 20 Hz, and 20 Hz to 10 Hz are referred to as one octave.

2. SPECIFICATIONS



2.2 Performance Specifications

This section describes the performance specifications and I/O conversion characteristics of 62DA.

2.2.1 Performance specifications

The performance specifications of 62DA are indicated in Table 2.2.

Item	Specifications																				
Digital input	Voltage output, digital setting range: ± 2000 Current output, digital setting range: ± 1000 .																				
Analog output	Selectively used depending on output terminals. Voltage: -10 to 0 to $+10$ V DC (External load resistance: 500Ω to $1\text{M}\Omega$) Current: $+4$ to $+20$ mA DC (External load resistance: 0Ω to 600Ω) -20 to 0 to $+20$ mA can also be used for current output.																				
I/O characteristics	<table border="1"> <thead> <tr> <th rowspan="2">Digital Input</th> <th colspan="2">Analog Output</th> </tr> <tr> <th>Voltage</th> <th>Current</th> </tr> </thead> <tbody> <tr> <td>+2000</td> <td>+10V</td> <td>-</td> </tr> <tr> <td>+1000</td> <td>+5V</td> <td>+20mA</td> </tr> <tr> <td>0</td> <td>0V</td> <td>+4mA</td> </tr> <tr> <td>-1000</td> <td>-5V</td> <td>-12mA</td> </tr> <tr> <td>-2000</td> <td>-10V</td> <td>-</td> </tr> </tbody> </table> <p>For details, refer to Section 2.2.2.</p>	Digital Input	Analog Output		Voltage	Current	+2000	+10V	-	+1000	+5V	+20mA	0	0V	+4mA	-1000	-5V	-12mA	-2000	-10V	-
Digital Input	Analog Output																				
	Voltage	Current																			
+2000	+10V	-																			
+1000	+5V	+20mA																			
0	0V	+4mA																			
-1000	-5V	-12mA																			
-2000	-10V	-																			
Maximum resolution	Voltage: 5mV ($1/2000$) Current: $20\mu\text{A}$ ($1/1000$)																				
Overall accuracy*	$\pm 1\%$ (voltage: 0.1V , current: 0.2mA)																				
Maximum conversion speed	Within $16\text{ms}/2$ channels (Time for 1 channel is also the same.) <i>Note: Time from when digital input is written to when analog voltage (current) changes from -10V (-20mA) to $+10\text{V}$ ($+20\text{mA}$).</i>																				
Absolute maximum output	Voltage: $\pm 12\text{V}$ <i>Note: Max. output voltage and current restricted by output protection circuit.</i> Current: $\pm 28\text{mA}$																				
Number of analog output points	2 channels/unit																				
Insulation method	Photocoupler insulation between output terminals and PC power (Non-insulated between channels)																				
Number of I/O occupying points	Special 64 points																				
Connection terminal	36-point terminal block																				
Applicable wire size	0.75 to 2mm^2 (Applicable tightening torque: 39 to $59\text{N}\cdot\text{cm}$)																				
Applicable solderless terminal	V1.25-3, V1.25-YS3A, V2-S3, V2-YS3A																				
Internal current consumption (5V DC)	0.55A																				
External supply power	Voltage	21.6 to 26.4VDC																			
	Current consumption	0.23A (at 24VDC)																			
	Inrush current	0.6A , 100ms (24VDC)																			
Weight kg (lb)	0.75 (1.65)																				

* This is the accuracy in respect to the maximum analog output value.

Table 2.2 Performance Specifications

POINTS

The analog output ranges for maximum resolution and maximum overall accuracy, is from -10 to 0 to $+10V$ or from -20 to 0 to $+20mA$.

When external power is supplied from the A0J2CPU or extension power supply, the number of connected units is restricted due to inrush current as described below:

Supplied from A0J2CPU

– Up to two units may be connected.

Supplied from A0J2PW

– Up to three units may be connected.

2.2.2 I/O conversion characteristics

I/O conversion characteristics are indicated by an inclination which is connected between an offset value and a gain value set in the test mode. Fig. 2.1 shows an example at the time of voltage output.

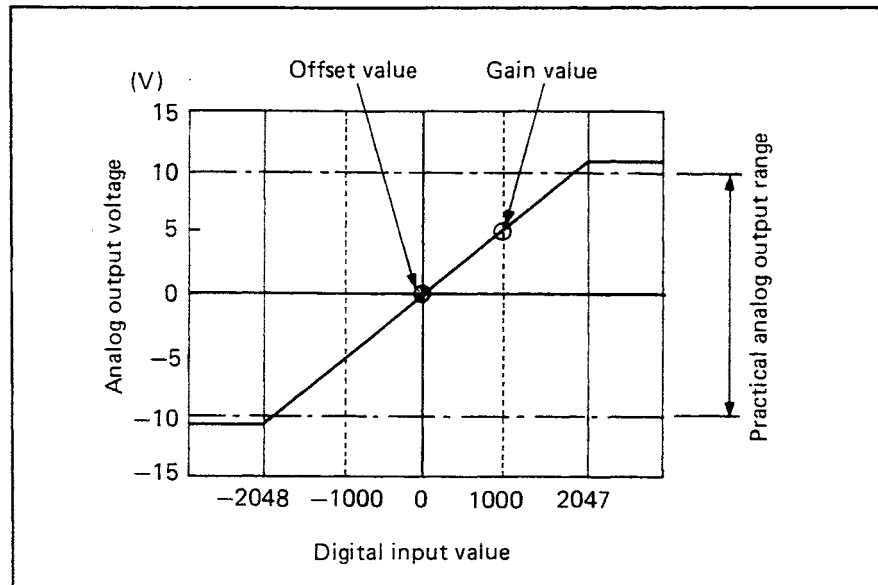

Fig. 2.1 I/O Conversion Characteristics

REMARKS

1. The offset value is the analog output voltage or current which is provided when the digital input value is 0. Set the offset value in test mode.
2. The gain value is the analog output voltage or current which is provided when the digital input value is 1000. Set the gain value in test mode.

(1) Voltage output characteristic

Fig. 2.2 shows a voltage output characteristic example for several offset/gain settings.

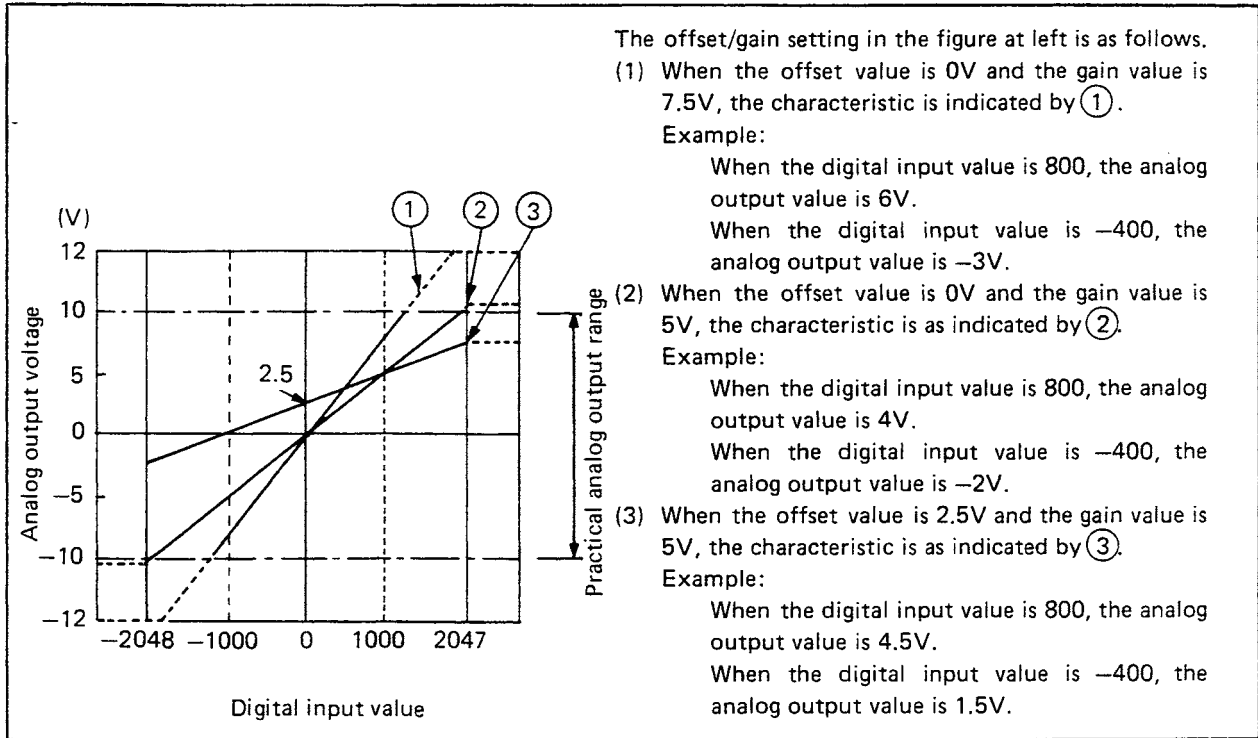

Fig. 2.2 Voltage Output Characteristic

POINTS

1. The maximum resolution and overall accuracy are within the range of performance specifications when the working analog output range is -10 to 0 to +10V. Avoid use outside the above indicated range (dotted line on the voltage output characteristic graph in Fig. 2.2).
 If the unit is used outside the practical analog output range, note the following:
 - 1) Prolonged use may lead to excessive rise in temperature and failure of the unit.
 - 2) Accuracy may not be within the range of performance specifications.
2. When the digital input value has been set to less than -2048 or more than +2047, analog output is provided with the digital input value regarded as -2048 or +2047.
3. The 62DA limits the maximum output voltage to -12 or +12V to protect against short circuit at the outputs. Therefore, even if the digital input value is set outside the range of output voltage limits, the output signal is limited to the maximum indicated.

(2) Current output characteristic

Fig. 2.3 shows a current output characteristic graph for several offset/gain settings.

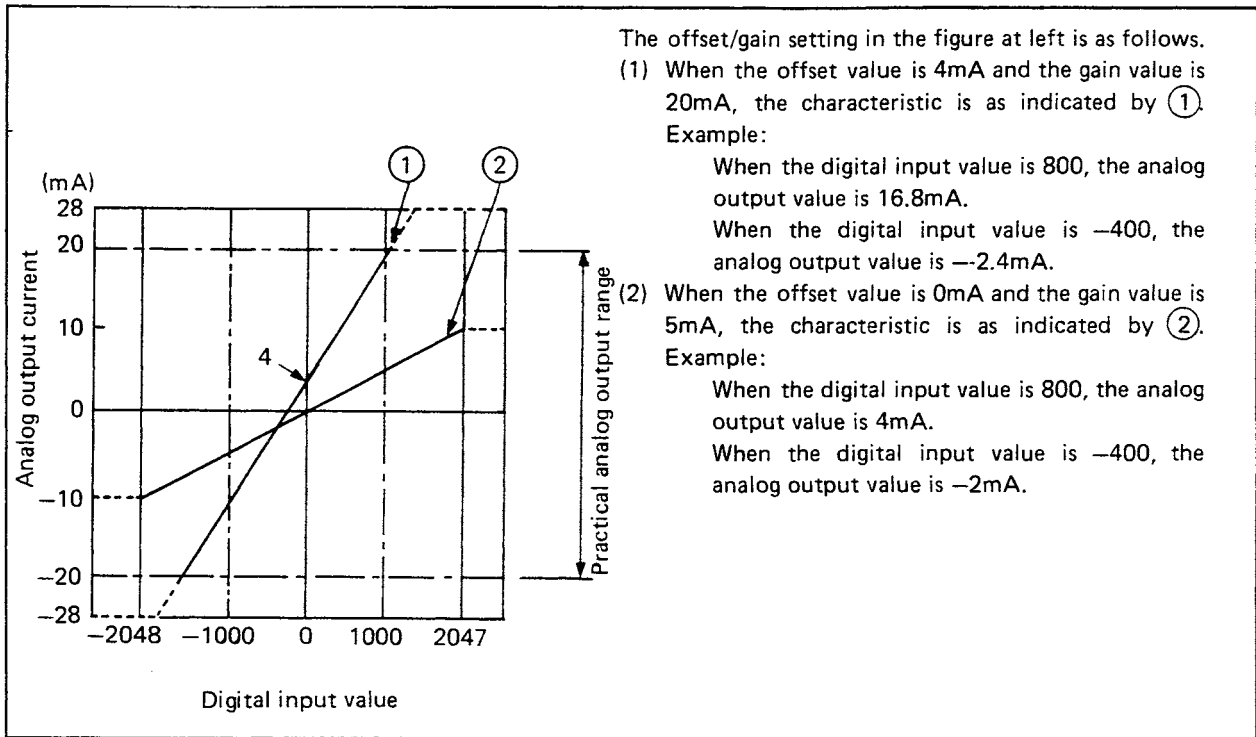

Fig. 2.3 Current Output Characteristic

POINTS

- The maximum resolution and overall accuracy are within the range of performance specifications when the working analog current range is -20 to 0 to +20mA. Avoid use outside the above indicated range (dotted line on the current output characteristic graph in Fig. 2.3).
If the unit is used outside the practical analog output range, note the following:
 - Prolonged use may result in excessive rise of temperature and failure of the unit.
 - Accuracy may not be within the range of performance specifications.
- When the digital input value has been set to less than -2048 or more than +2047, analog output is provided with the digital input value regarded as -2048 or +2047.
- The 62DA limits the maximum output current to -28mA or +28mA to protect against short circuits at the outputs. Therefore, even if the digital input value is set outside the range of output current limits, the output signal is limited to the maximum indicated.

(3) Relation between offset/gain setting and analog output value

The resolution of the 62DA can be changed by the offset/gain setting. To calculate the resolution and analog output values for various digital input value, use the following expressions.

$$(\text{Resolution}) = \frac{(\text{gain value}) - (\text{offset value})}{1000}$$

(Analog output)

$$= \frac{(\text{gain value}) - (\text{offset value})}{1000} \times (\text{digital input value}) + (\text{offset value})$$

$$= (\text{resolution}) \times (\text{digital input value}) + (\text{offset value})$$

If the resolution is in units of 5mV or 20μA, the variation of analog output value differs depending on the setting of offset and gain for a change of 1 in the digital input value.

Fig. 2.4 and 2.5 show the relation between the digital input value and the analog output value when the offset/gain setting is changed. The offset value and gain value are values in the voltage and current output characteristic graphs in Fig. 2.2 and 2.3.

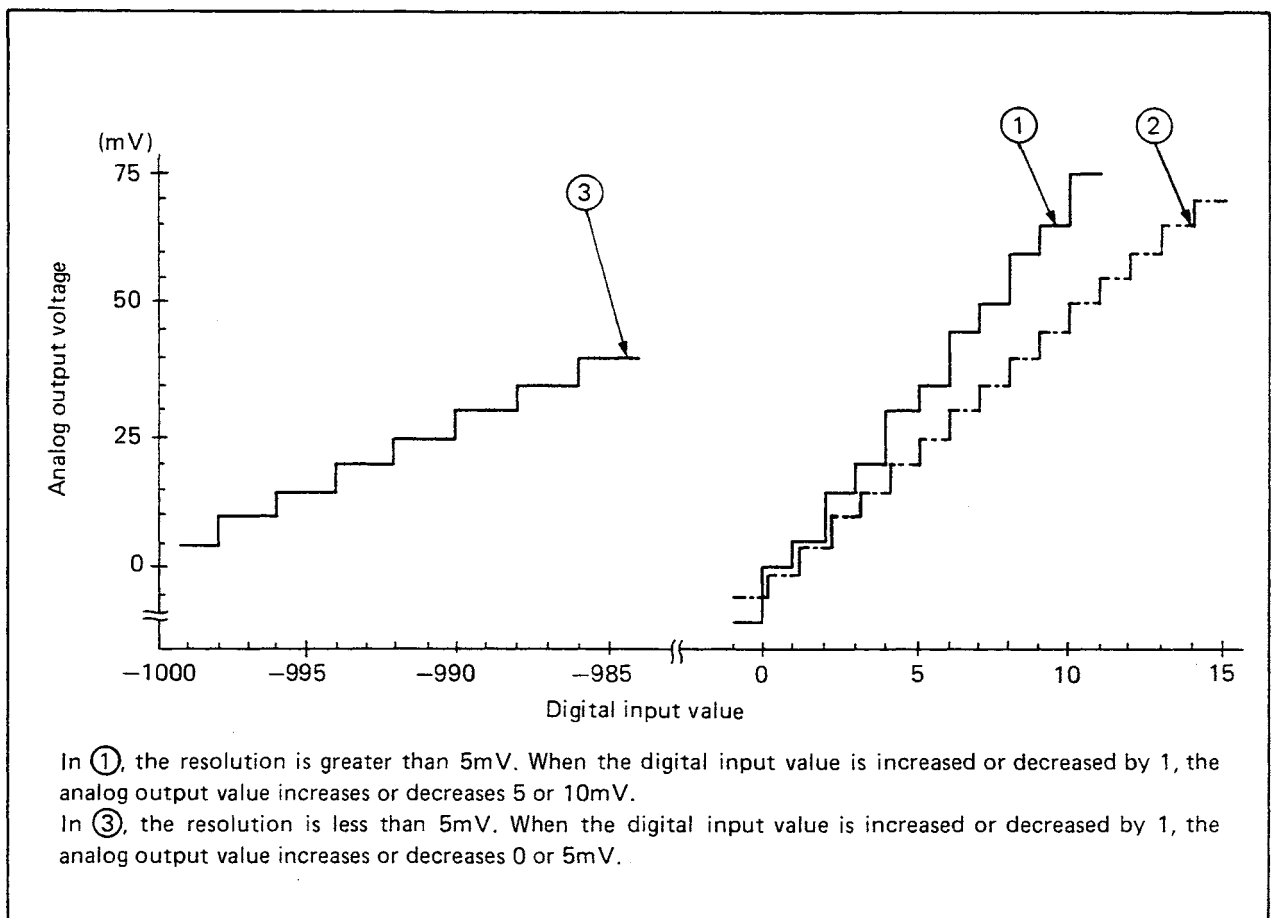

Fig. 2.4 Digital Input Value and Voltage Output

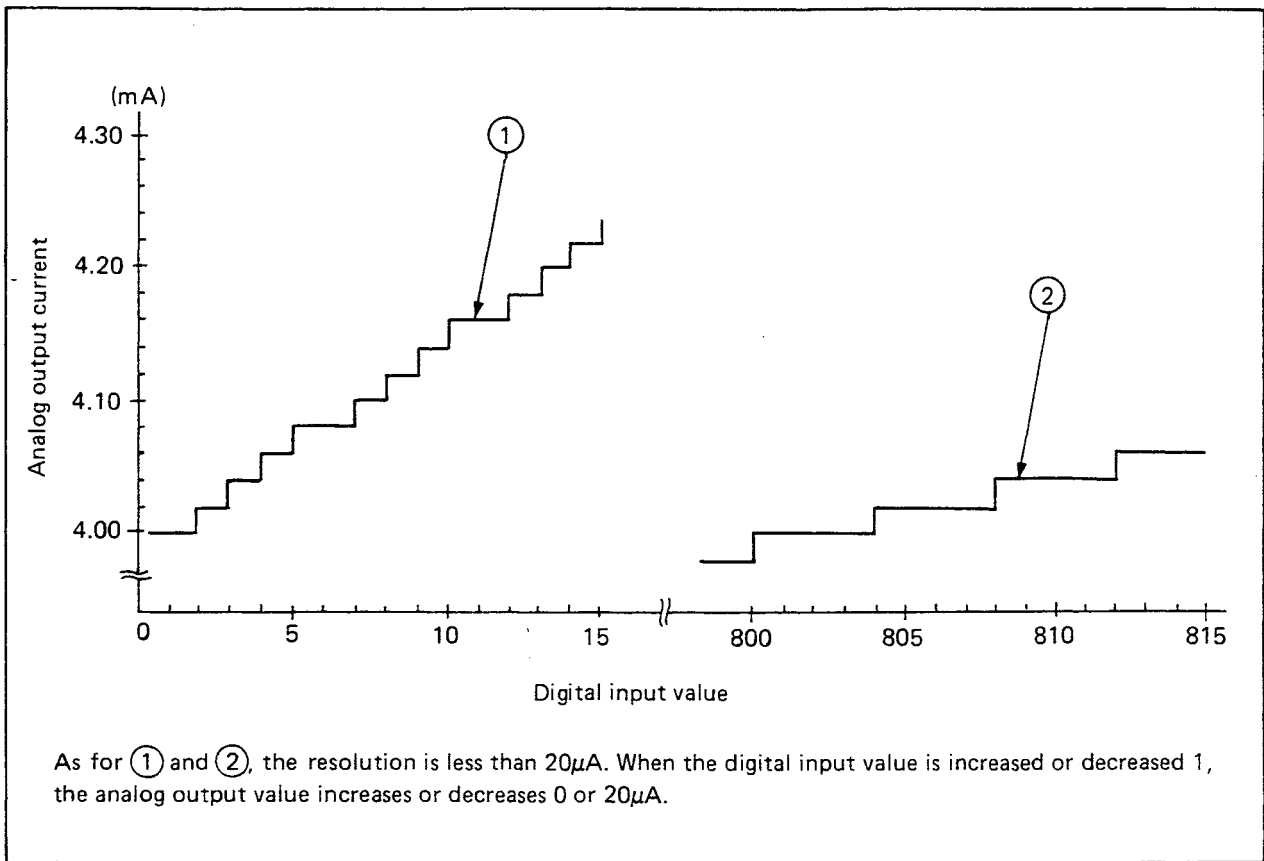

Fig. 2.5 Digital Input Value and Current Output

(4) Overall accuracy

The overall accuracy is the accuracy in respect to the maximum analog output value.

Even if the input characteristics are changed by changing the offset/gain settings, the overall accuracy will not change and will be kept within the range of the performance specifications. The overall accuracies of the power/current output characteristics are shown in Fig. 2.6 and Fig. 2.7.

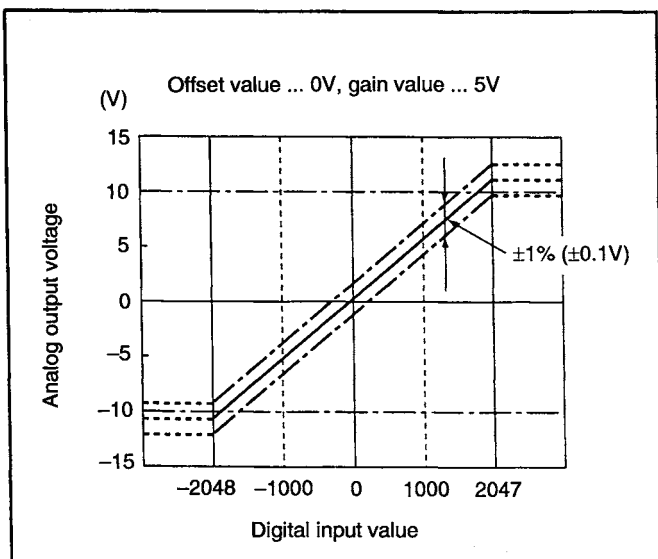

Fig. 2.6 Overall accuracy of voltage output characteristics

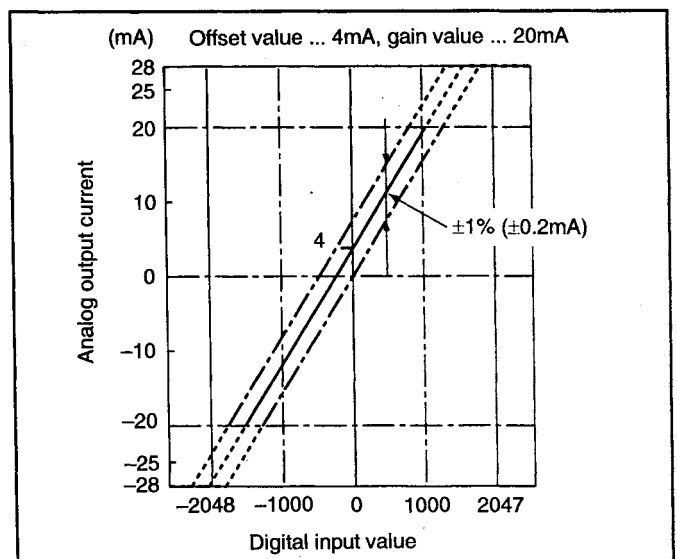

Fig. 2.7 Overall accuracy of current output characteristics

2.3 I/O List with Respect to Programmable Controller CPU

The I/O signals for the 62DA with respect to the programmable controller CPU are as indicated below. Numbers provided for X and Y are determined by the loading position of the A62DA unit and the number of points of other I/O units.

The following I/O numbers assume that the unit number is set to 0.

2.3.1 I/O list

(1) Inputs for programmable controller CPU X0 – X1F (32 points).

Input Signal	Description
X0	Watch dog timer error Turns on if a watch dog timer error occurs in the A62DA.
X1	D/A conversion ready (1) Turns on when D/A conversion is ready in normal mode (not in test mode) after the power is turned on or the programmable controller CPU is reset. Turns off when normal mode is changed to test mode. (2) Used as an interlock when read or write is performed from the programmable controller CPU to the 62DA.
X2 to X1F	Not used

(2) Outputs for programmable controller CPU X0 – X1F (32 points).

Output Signal	Description
Y0 to Y1A	Not used
Y1B	Output enable Used for both channels 1 and 2. Depending on the status of signal, analog output differs. (1) OFF The offset value is output as an analog value. (2) ON The analog value has been converted from the digital value, is output.
Y1C to Y1F	Not used

IMPORTANT

Do not use devices Y0 – Y1A and Y1C – Y1F in the normal sequence program.

If they are used (turned ON/OFF) in a sequence program, it will not be possible to guarantee correct functioning of the 62DA.

Note, however that if the 62DA is used in a remote I/O system, resetting Y0E and Y0F is permitted. For details, refer to the A0J2 Data Link User's Manual.

2.3.2 I/O signals and analog output

- (1) Relation between I/O signals and analog output in normal mode is indicated in the following table.

Output enable Y1B	OFF		ON	
D/A conversion ready X1	OFF	ON	OFF	ON
Analog output value	0V	Offset value	0V	The digital value written from the programmable controller CPU, is converted into an analog value which is output.
Remarks		The offset value with offset/gain set is output as an analog value.		Until a digital value is written, the offset value is output as an analog value.

- (2) In test mode, the D/A conversion ready (X1) signal turns off. Regardless of the digital input value, analog values shown in the following table are output depending on the positions of channel select switch and OFFSET/GAIN select switch.

Position of channel select switch Channel of analog output	CH1		CH2	
	Channel 1	Channel 2	Channel 1	Channel 2
Position of OFFSET/GAIN select switch				
OFFSET position	Offset value of channel 1	Offset value of channel 2	Offset value of channel 1	Offset value of channel 2
SET position	Gain value of channel 1			Gain value of channel 2

2.4 Buffer Memory

The 62DA is equipped with a buffer memory (which is not battery backed) for the communication of data with the programmable controller CPU. The following gives an explanation of the assignment and data configuration of this buffer memory.

For read and write of data by the sequence program, refer to Chapter 6 (page 6-1).

2.4.1 Assignment of buffer memory

The assignment of buffer memory is indicated below.

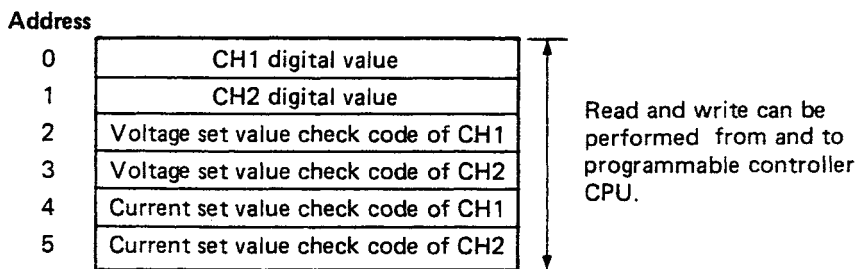

*Each data consists of 16 bits.

2.4.2 Contents and data configuration of buffer memory

This section describes the contents and data configuration of the buffer memory for each item indicated in Section 2.4.1.

(1) Digital value (CH1, CH2)

- a) When the power is turned on and the D/A conversion ready signal is on, the digital value is 0.
- b) Set a digital value, -2048 to +2047, in 16-bit binary with sign.

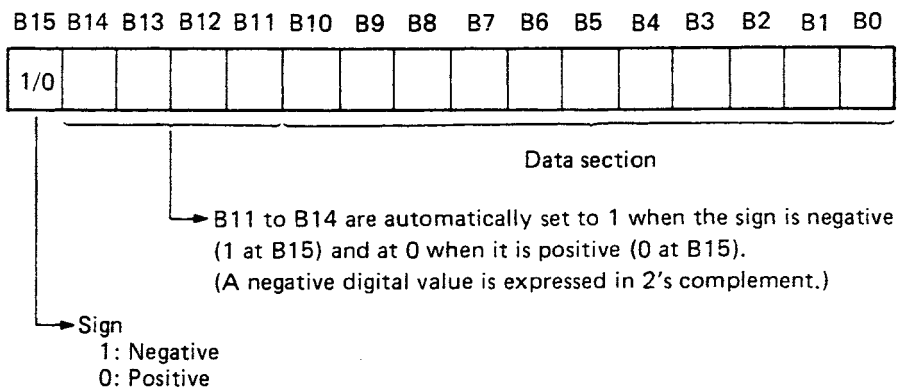

POINT

If the digital value has been set outside its range, D/A conversion is made with the set value regarded as the usable maximum value or minimum value.

Example: When -3000 is set, the value is treated as -2048 .
When $+3000$ is set, it is treated as $+2047$.

(2) Voltage set value check (CH1, CH2)

When the digital value is set to -2001 or less or to $+2001$ or more, one of the following check codes is set for each channel.

Check Code	Description
000F	The digital value has been set to $+2001$ or more.
00F0	The digital value has been set to -2001 or less.
00FF	The digital value is outside the range -2000 to $+2000$.

*Check codes are expressed in hexadecimal.

(3) Current set value check (CH1, CH2)

When the digital value is set to a negative value or to $+1001$ or more, one of the following check codes is set for each channel.

Check Code	Description
000F	The digital value has been set to $+1001$ or more.
00F0	The digital value has been set to a negative value.
00FF	The digital value is outside the range 0 to $+1000$.

*Check codes are expressed in hexadecimal.

POINTS

1. If the digital value is a negative value or $+1001$ or more in the case of analog voltage output, the current set value check codes will be set to 4 (CH1) and 5 (CH2) of buffer memory.
2. Reset the check codes by use of the sequence program in the programmable controller CPU. For details, refer to Chapter 6 (page 24).

3. HANDLING

This chapter describes the handling instructions, nomenclature, maintenance, and inspection of the 62DA.

3.1 Handling Instructions

- (1) Protect the 62DA and its terminal block from impact.
- (2) Do not touch or remove the printed circuit board from the case.
- (3) When wiring, ensure that no wire offcuts enter the unit and remove any that do enter.
- (4) Tighten terminal screws as specified below.

Screw	Tightening Torque Range (N-cm)
I/O terminal block terminal screw (M3 screw)	39 to 59
I/O terminal block mounting screw (M4 screw)	78 to 118
Module mounting screw (M4 screw)	78 to 118

3.2 Nomenclature, Settings and Checking

3.2.1 Nomenclature

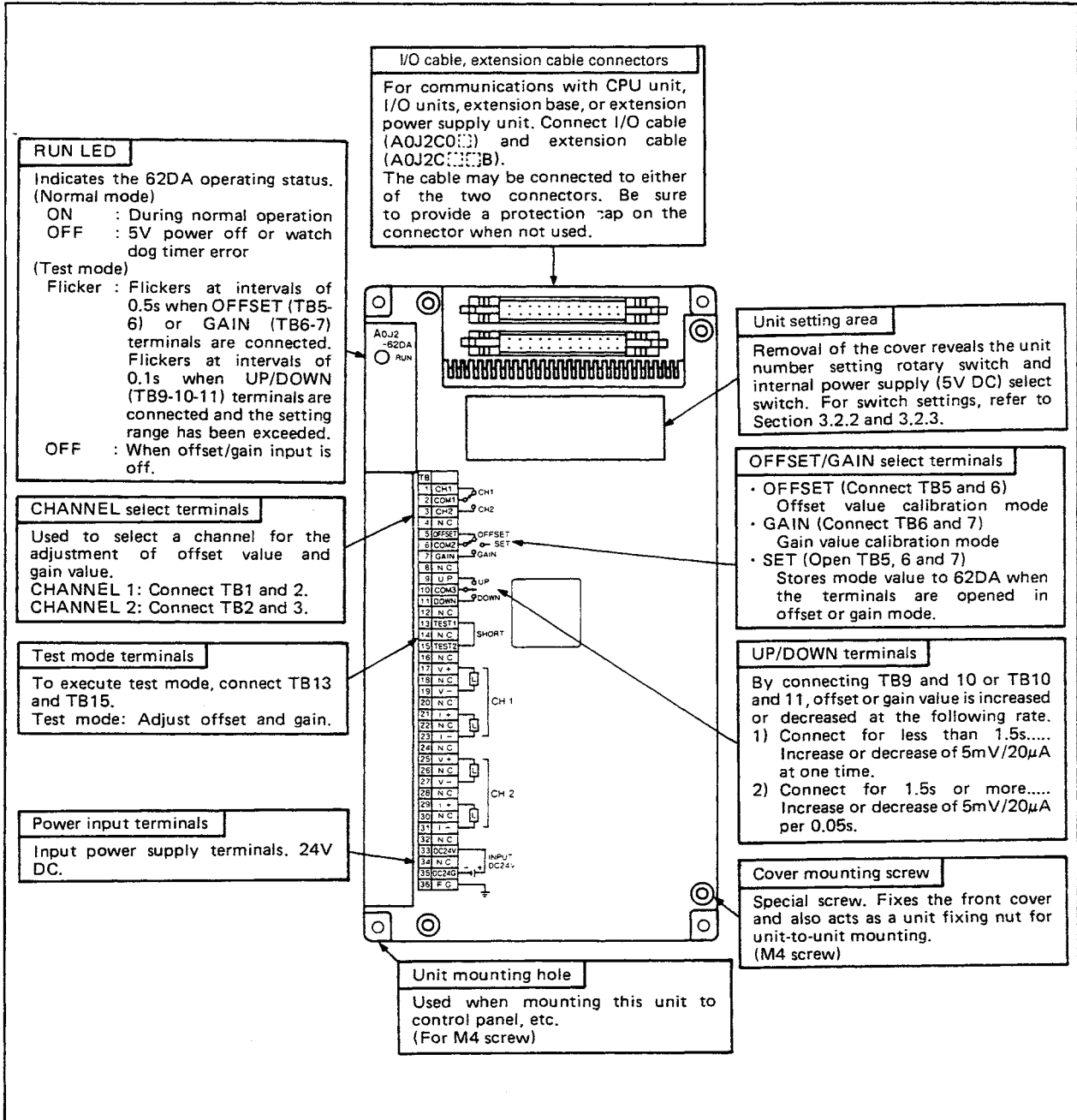

REMARK

It is necessary to set the area in prior to test operation and adjustments.

3.2.2 Unit number setting

This section describes unit number setting.

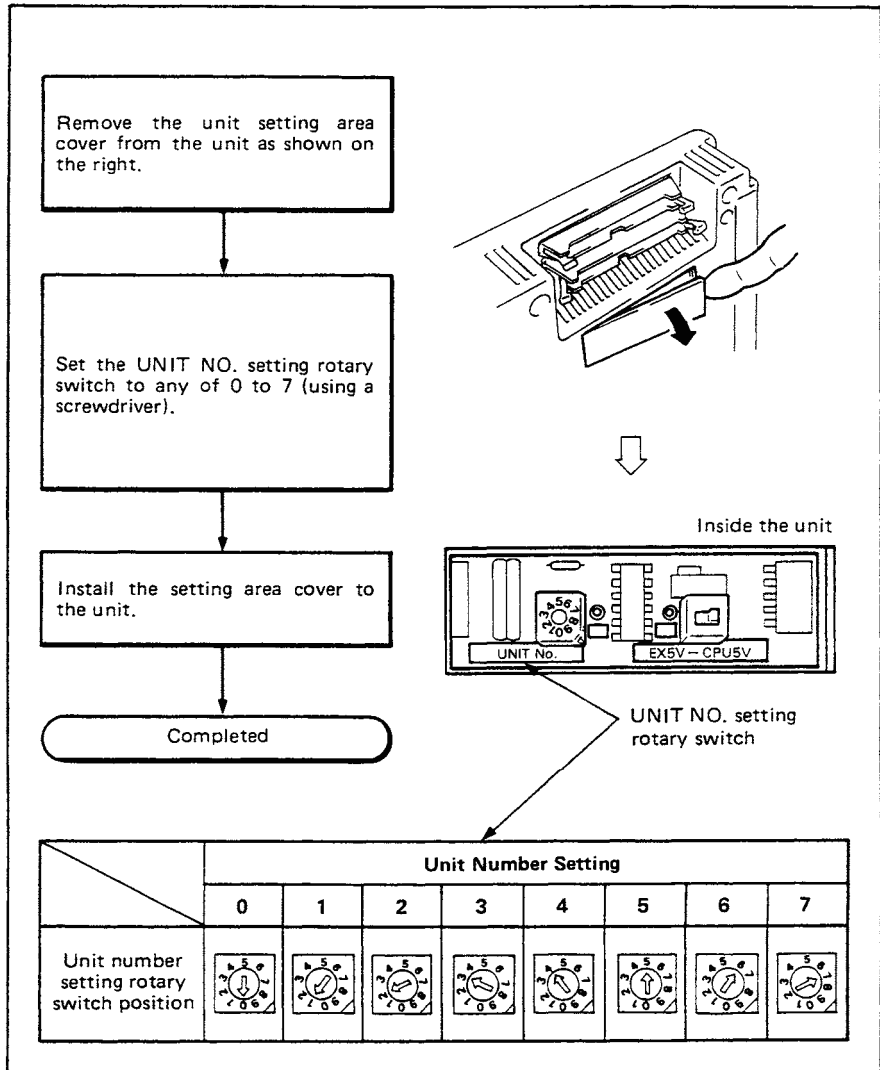

POINTS

- (1) Set the unit number setting rotary switch to any of 0 to 7 according to the unit stage number. Note if that the same unit number is set to two or more units, misinput and misoutput will occur.
- (2) The unit number setting determines X and Y addresses. For details, refer to Chapter 5.

3.2.3 Internal power supply (5 VDC) setting

Set the internal power supply (5 VDC) of the 62DA as explained below.

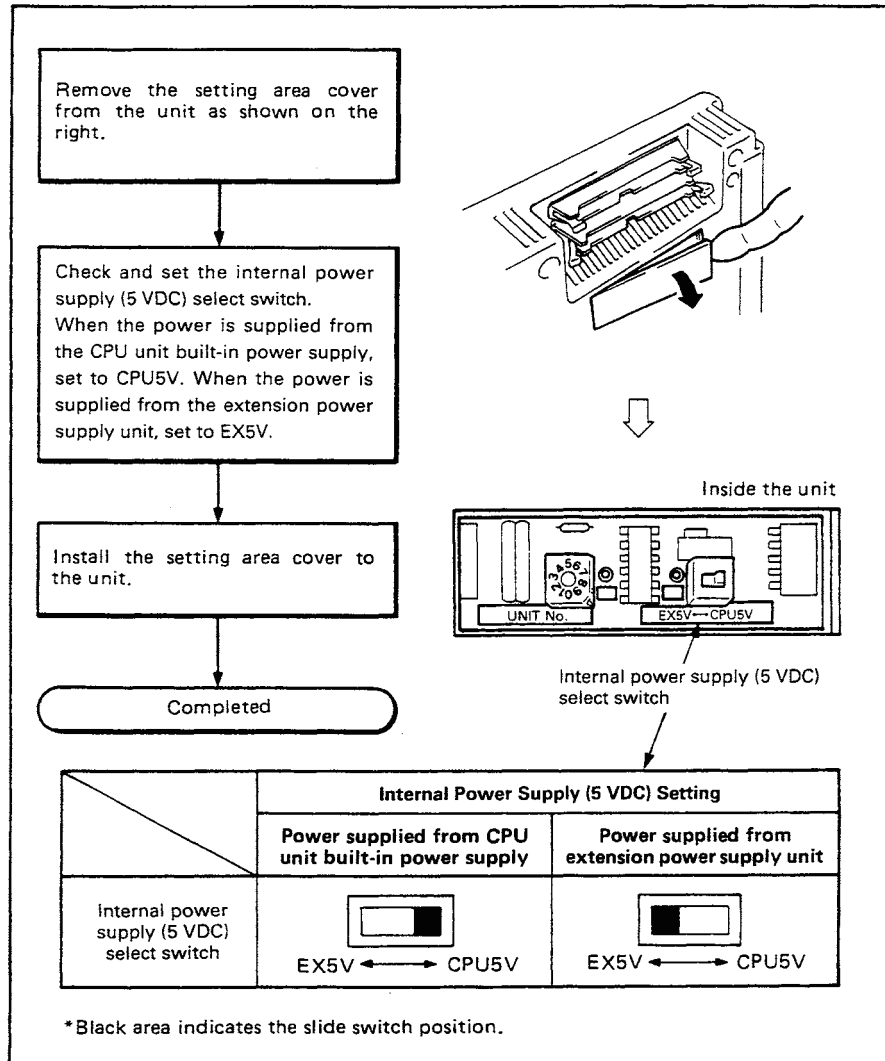

POINTS

- (1) If the select switch is set to EX5V when 5 VDC is supplied from the internal power supply of the CPU unit to the 62DA, the 62DA does not operate properly. Always check this before test operation.
- (2) To set the internal power supply in a system which uses the A0J2PW extension power supply unit, refer to Section 5.2 of the A0J2CPU User's Manual (CPU unit edition).

3.2.4 Internal power supply (5 VDC) checking

Check the internal power supply (5 VDC) of the 62DA as explained below using a circuit tester.

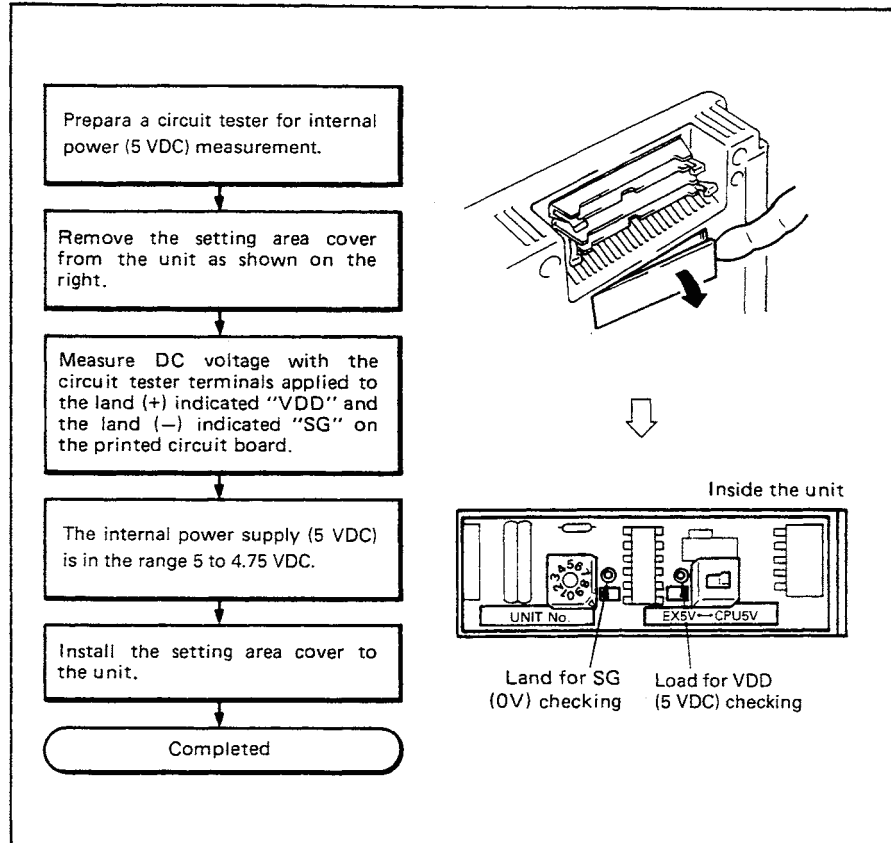

4. WIRING

4.1 Wiring Instructions

Protect external wiring against noise with the following precautions:

- (1) Separate AC and DC wiring.
- (2) Separate main circuit and/or high voltage wiring from control and signal wiring.
- (3) Where applicable, ground the shielding of all wires to a common ground point.

4.2 Unit Connection Example

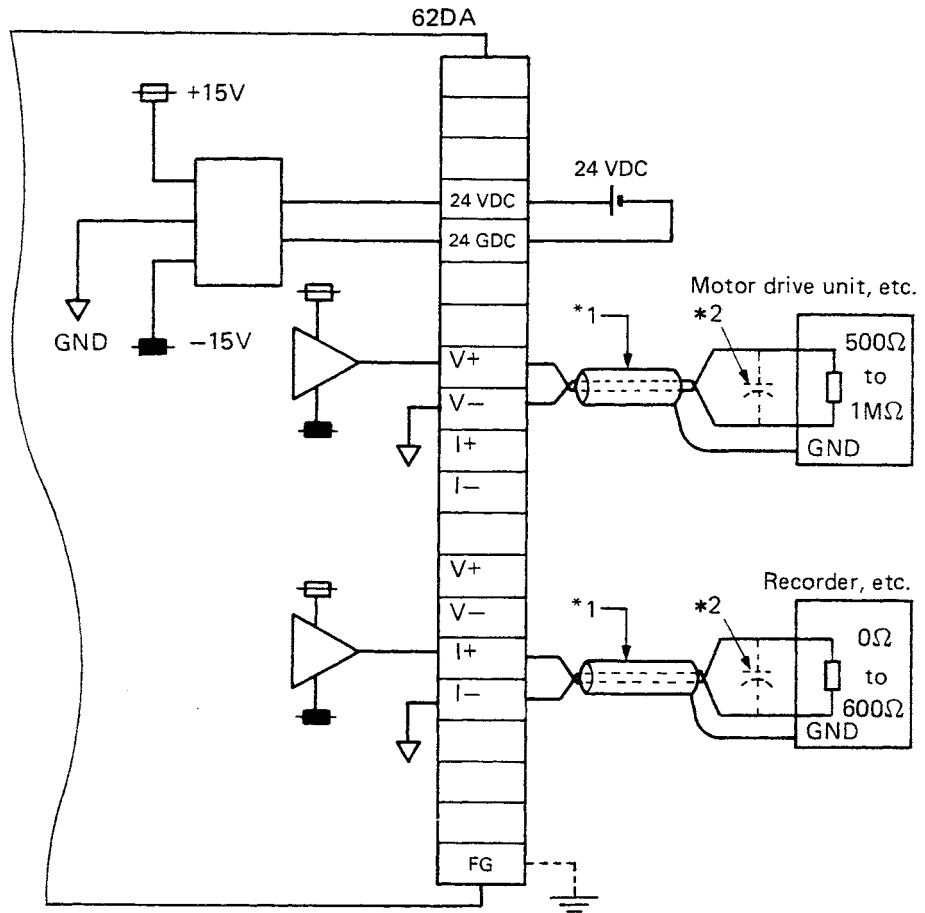

*1: Use two core, shielded wiring (twisted).

*2: If noise or ripple is generated by the external wiring, connect a 0.1 to 0.47μF (25V or more voltage resistance parts.) capacitor to the input terminal of external equipment. At the same time, ground FG of the 62DA and FG of the power supply unit.

IMPORTANT

A given channel cannot be used for voltage and current outputs at the same time. Only use one set of terminals on each channel.

5. CONCEPT OF THE 62DA I/O NUMBERS IN A0J2 SYSTEM

This chapter explains the concept and precautions for the 62DA I/O numbers in the A0J2 system.

5.1 I/O Number Assignment and Concept

The I/O number assignment is one of the requirements for constructing a system. Wrong assignment will result in failure. Assign the I/O numbers as described below.

- (1) X and Y represent input and outputs, respectively. I/O numbers are addressed in hexadecimal. (0 to F)
- (2) I/O numbers are determined by the unit number set in the 62DA. One unit occupies 64 points.

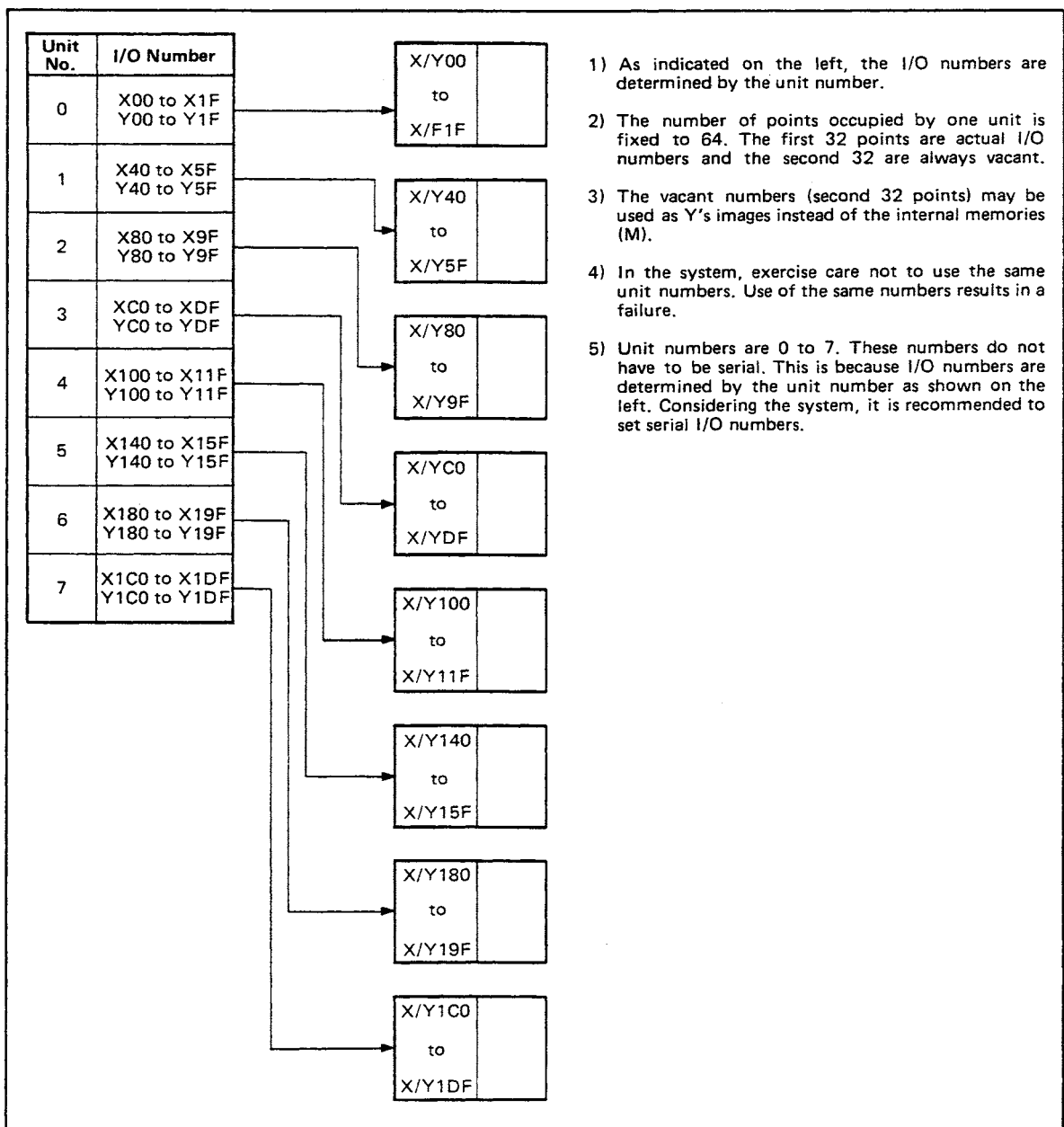

6. PROGRAMMING

6.1 Initial Setting

This section describes a programming procedure for using the 62DA. Perform the initial setting of the 62DA from the PC CPU in the procedure shown in Fig. 6.1.

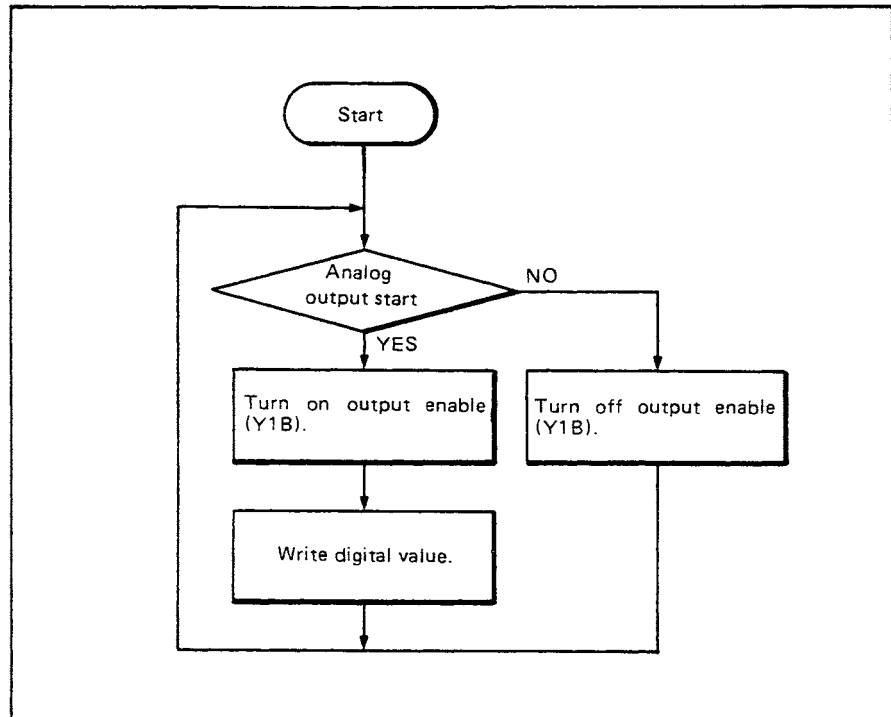

Fig. 6.1 Initial Setting Procedure

I/O numbers shown below are applicable when the unit number is set to 0. For I/O numbers with respect to the PC CPU and buffer memory assignment, refer to Section 2.4.1

6.2 Programs

This section describes basic programs for reading and writing, writing of digital values, and practical ladder examples. For details on instructions, refer to the A0J2CPU Programming Manual. When using the 62DA at a remote I/O station, also refer to the data link unit User's Manual.

6.2.1 Basic programs for read and write

(1) Read from 62DA : FROM, DFRO instructions

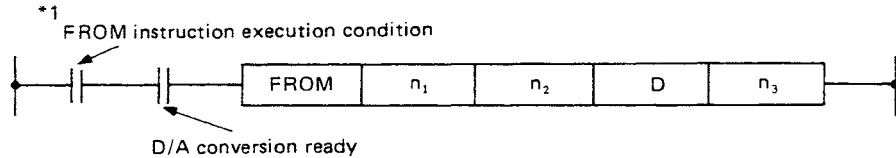

Symbol	Description	Usable Device Number
n ₁	Upper 2 digits of 3-digit hexadecimal head I/O number assigned to 62DA.	K, H
n ₂	Head address of buffer memory which stores data	K, H
D	Head number of device which will store read data	T, C, D, W
n ₃	Number of words of data to be read	K, H

Example: To read the 2 word data from address 2 of the buffer memory to D0 and 1, with the 62DA assigned to I/O X00 to 1F and Y00 to 1F

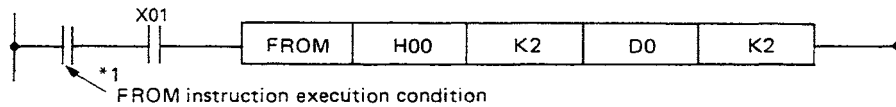

(2) Write to 62DA : TO, DTO instructions

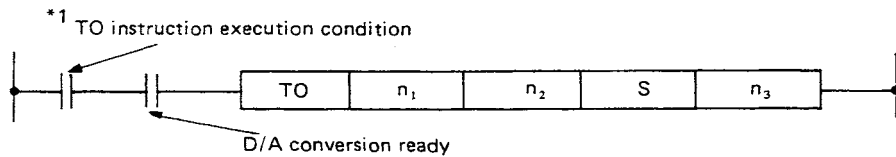

Symbol	Description	Usable Device Number
n ₁	Upper 2 digits of 3-digit hexadecimal head I/O number assigned to 62DA.	K, H
n ₂	Head address of buffer memory which will store data	K, H
S	Head device number or constant where data to be written is stored.	T, C, D, W
n ₃	Number of words of data to be written	K, H

Example: To write 500 to address 0 of the buffer memory, with the A62DA assigned to I/O X60 to 7F and Y60 to 7F

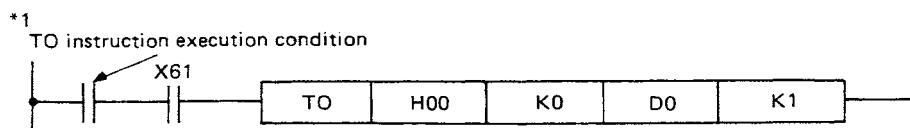

REMARK

Convert the instruction marked *1 into pulse.

6.2.2 Write of digital value

This section shows the voltage output and current output for an example program which writes the digital value in data register D5 to channel 1.

(1) Voltage output

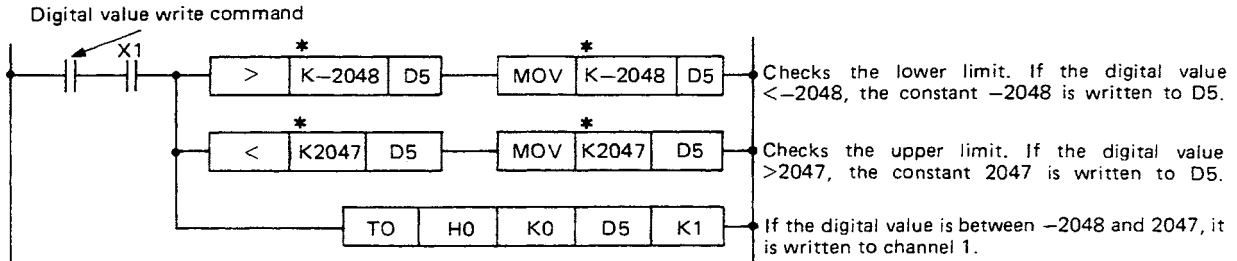

(2) Current output

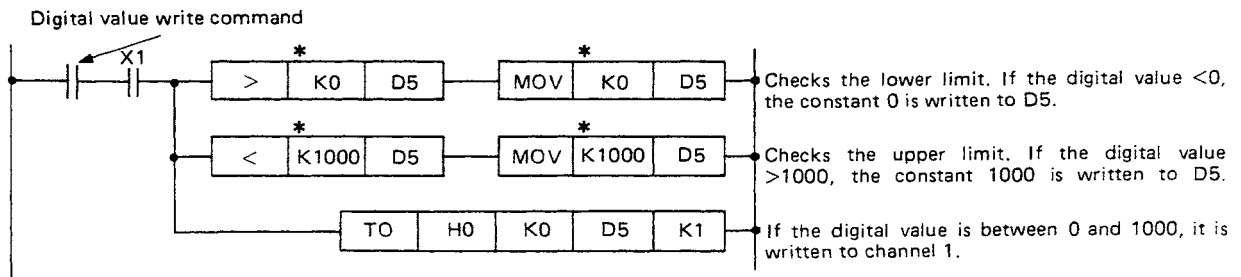

POINT

When digital values are written to the 62DA, you are recommended to perform an upper limit/lower limit check on the values using the sequence program. Values marked with an asterisk "*" are subject to upper and lower limit value restrictions for voltage or power and must only be changed within the specified limits when programming.

6.2.3 Reset of check codes

Batch reset of check codes (addresses 2 to 5 of the buffer memory) of channels 1 and 2.

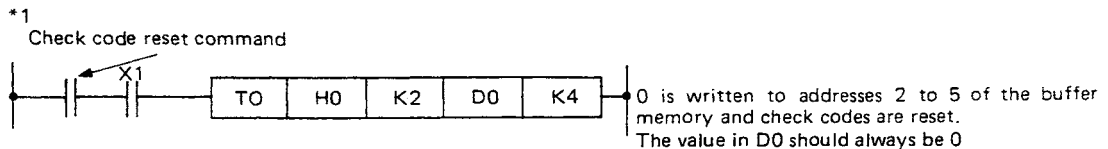

REMARK

Convert the instruction marked *1 into pulse.

6.2.4 Application circuit examples

POINT

The application circuit examples given here are basic circuits. Consider interlock conditions in relation to the system you are using.

(1) Program giving a voltage analog output from 62DA channel 1 to an inverter for control of 4 set speeds.

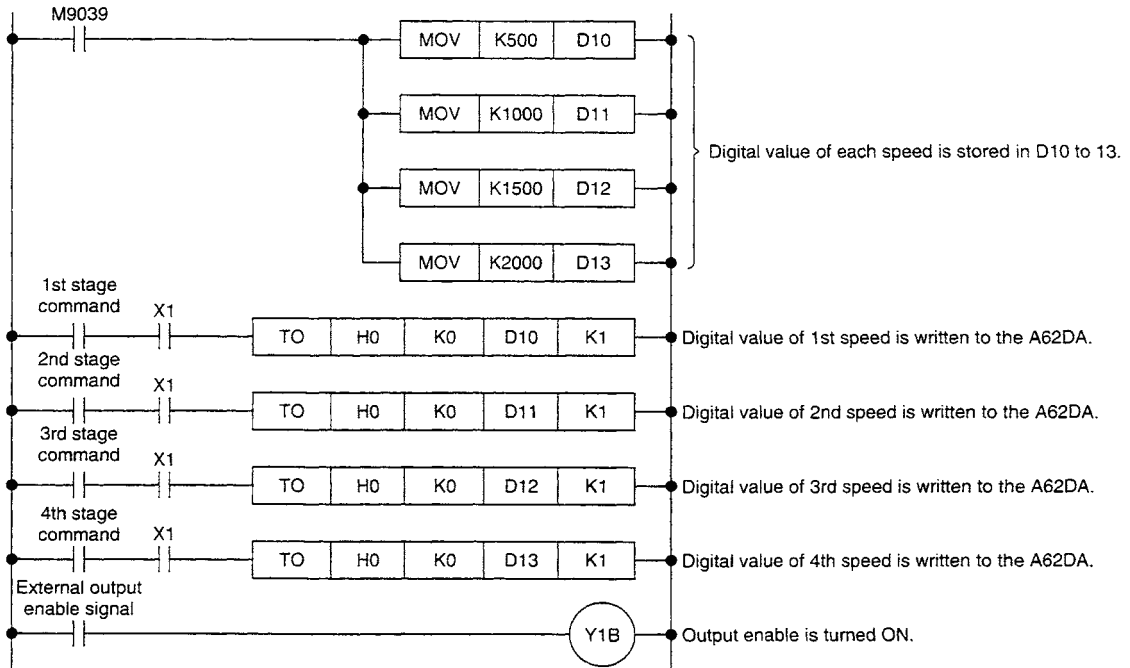

(2) Example which provides output to Y60 and Y61 when a digital value setting error occurs during use of analog current output from channel 1. This example also resets the voltage and current set value check codes of channel 1 when X40 turns on.

Check Code	Y60	Y61
000F	ON	OFF
00F0	OFF	ON
00FF	ON	ON

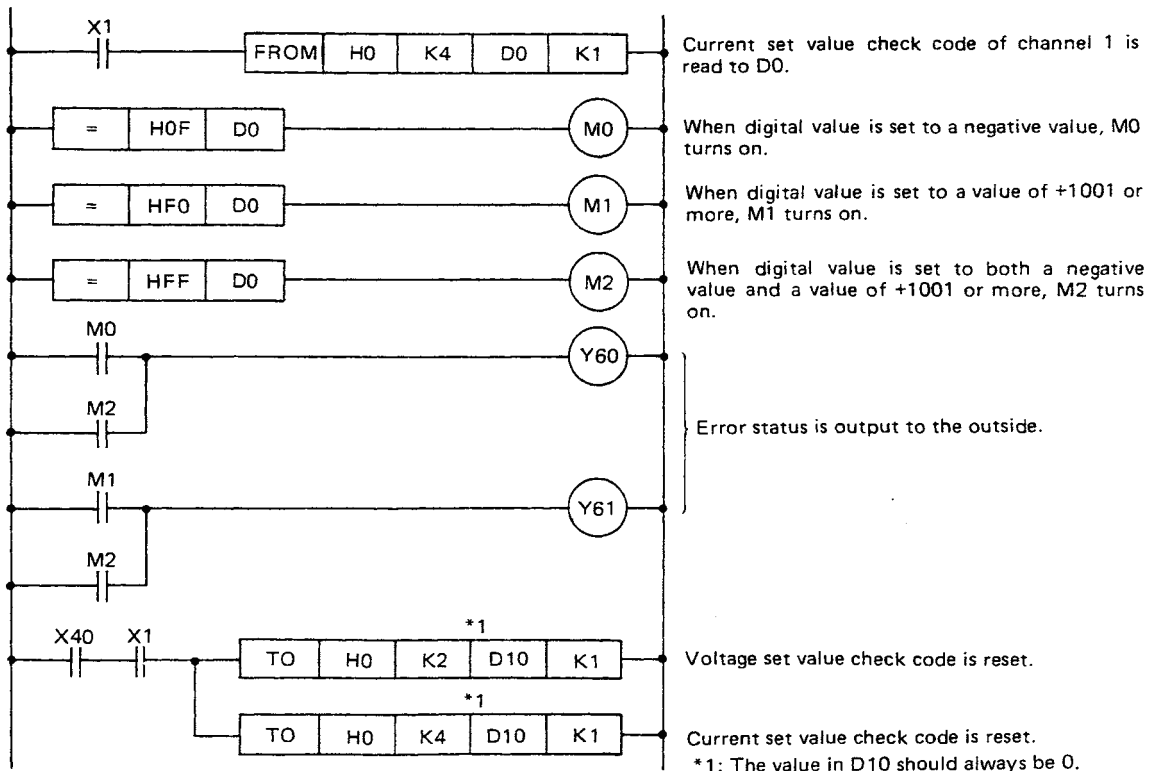

7. TEST OPERATION AND ADJUSTMENTS

This section describes the offset/gain settings necessary before test operation on the 62DA, and the points to check before starting operation. Also refer to the information on test operation and adjustments in the CPU unit User's Manual.

7.1 Offset/Gain Setting

The offset/gain setting can be performed in test mode within the following ranges.

	Voltage (V)	Current (mA)
Offset value	-3 to +3 DC	-12 to +12 DC
Gain value	-2 to +10 DC	-8 to +20 DC

Table 7.1 Offset/Gain Setting Range

* Factory setting: offset = 0V Gain value = 5V

POINTS
<ol style="list-style-type: none"> The setting range of the gain value depends on the offset value as follows: Gain range = (Offset value + 1) to +10V (Voltage setting) or Gain range = (Offset value + 4) to +20mA (Current setting) Example: If the offset value has been set to 0V, the gain value can be set within the range +1 to +10V. If offset (gain value) adjustment is taken outside the range shown in Table 7.1, the RUN LED flickers faster (0.1s). The offset and the gain value are remained in the 62DA without power.

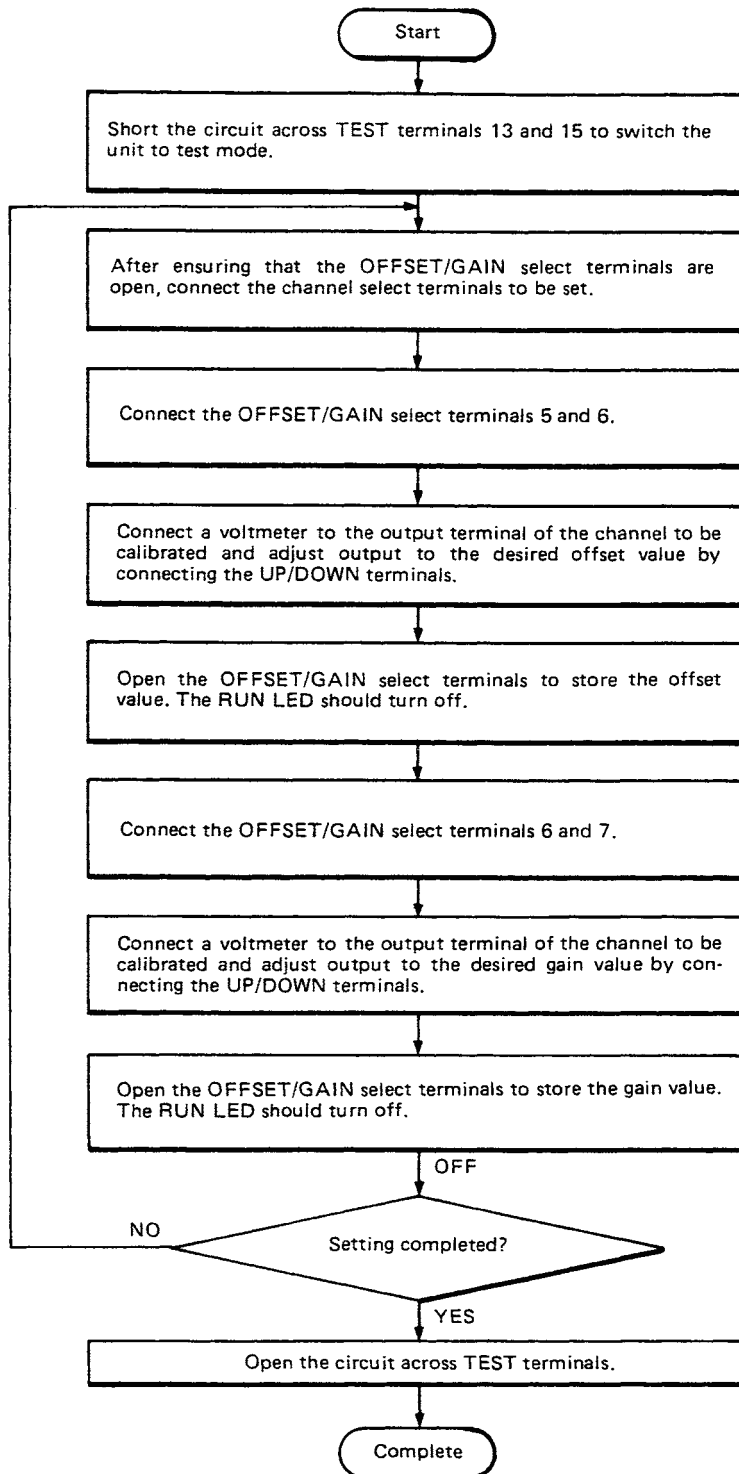

POINTS

1. Do not set the 62DA to test mode during its normal control operation. All channels stop D/A conversion in test mode, normal control cannot be performed. By returning the 62DA to normal mode again, D/A conversion is resumed at the newly calibrated gain/offset setting. For the analog output value in test mode, refer to Section 2.3.2
2. Set the offset/gain value within the range -10 to 0 to +10V DC or from -20 to 0 to +20mA DC. If setting has been performed outside this range, maximum resolution and overall accuracy may not be within the range of performance specifications.
3. If the RUN LED flickers at high speed (5Hz) when the offset/gain setting range has been exceeded, this excessive value cannot be set into the 62DA and the previously set value is retained.
4. When switching the channel for the offset/gain setting, make sure the offset/gain selection terminals are OPEN. If the channel is switched while the terminals are set to the OFFSET or GAIN position and then the terminals are set to OPEN after channel switching, the offset value or gain value will be overwritten and will have to be set again.

IMPORTANT

If the CPU is reset in test mode with the OFFSET/GAIN select switch and UP/DOWN switch at the positions described below, proper D/A conversion cannot be made. Therefore, never reset the CPU with the above mentioned switches fixed at such positions. Should the CPU have been reset as described above, restore the system by opening the circuit across the test terminals or by resetting the programmable controller CPU with the switches in their normal positions.

OFFSET/GAIN Select Switch	UP/DOWN Switch	Phenomenon
OFFSET position	DOWN position	Watch dog timer error (X0) signal turns on and analog output is set to 0V (0mA).
GAIN position	DOWN position	Offset/gain setting cannot be performed.

7.2 Check Points before Start of Operation

Check the points listed in Table 7.2 before starting test operation of the 62DA.

Number	Checking Point	Description	Check
1	Loading of unit	Is the I/O assignment for the 62DA slot correct?	
2	Offset/gain setting	Has offset/gain setting been performed for all channels used?	
		Check for setting errors.	
		Has the unit been returned to normal mode by opening the circuit across TEST terminals?	
3	Connection to 62DA	Does the cable connected to each terminal of terminal block match a signal? Have cables been connected correctly?	
		Are the terminal screws on the terminal block tightened securely?	
		Is the cable size correct?	
		Is the 24 VDC connected correctly?	

Table 7.2 Check Points

8. TROUBLESHOOTING

This chapter describes simple troubleshooting procedures for the 62DA. For the CPU unit, refer to the A0J2 Programming Manual.

8.1 Troubleshooting Flow Chart

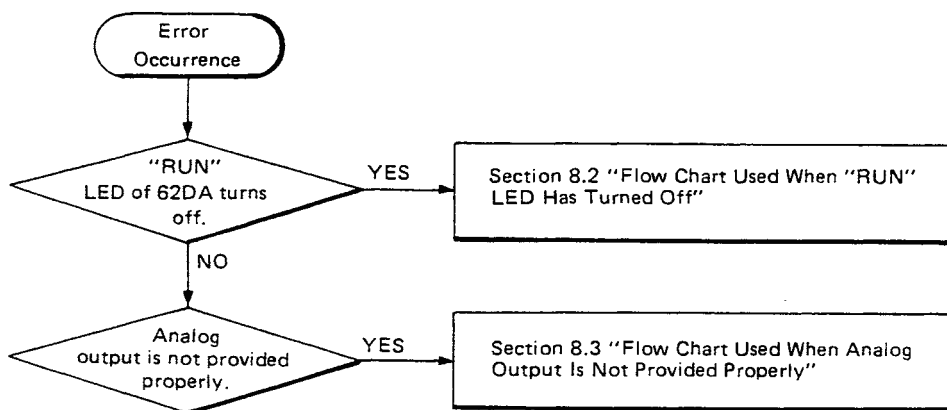

8.2 Flow Chart Used When "RUN" LED Has Flickered or Turned Off

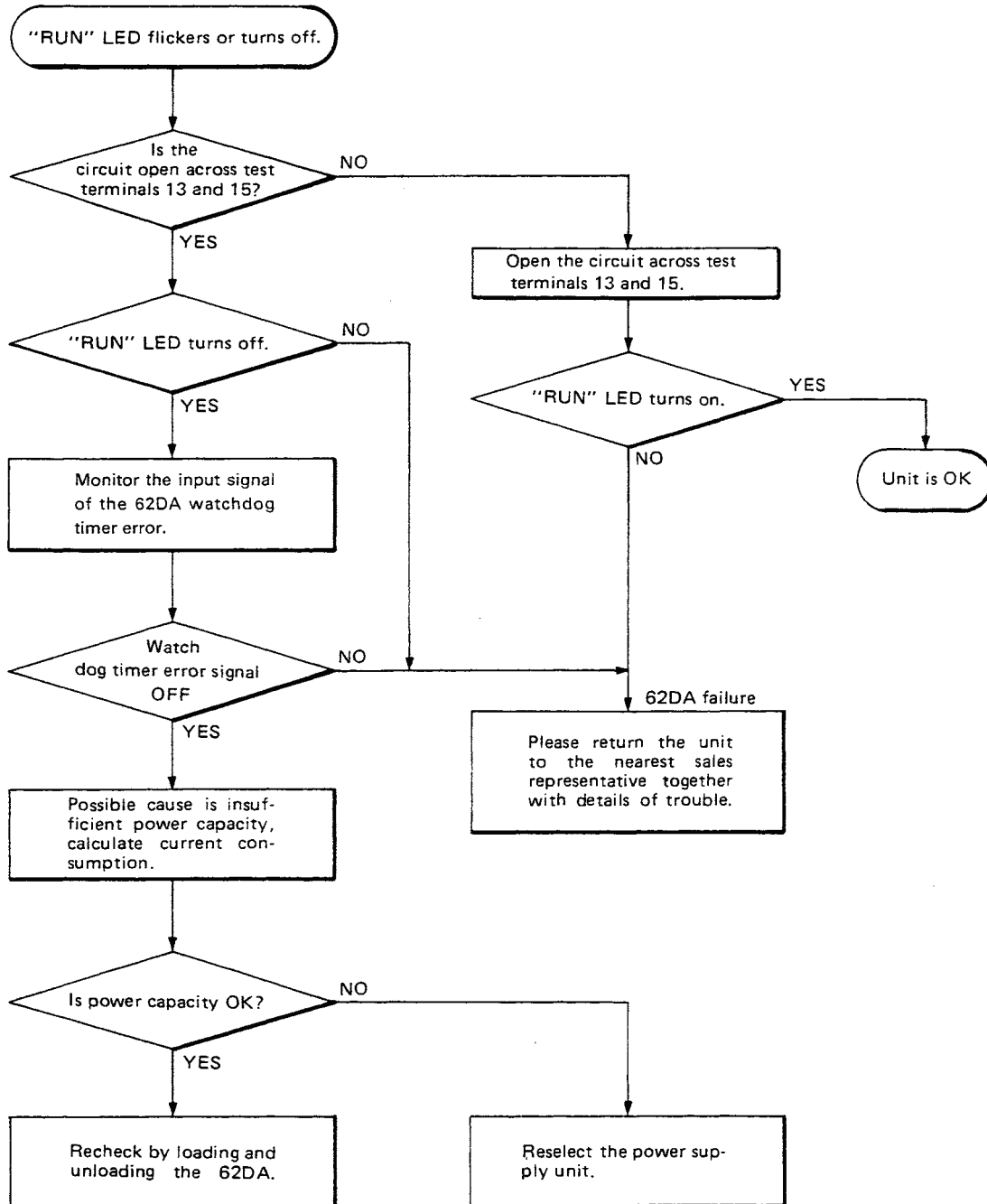

8.3 Flow Chart Used When Analog Output Is Not Provided Properly

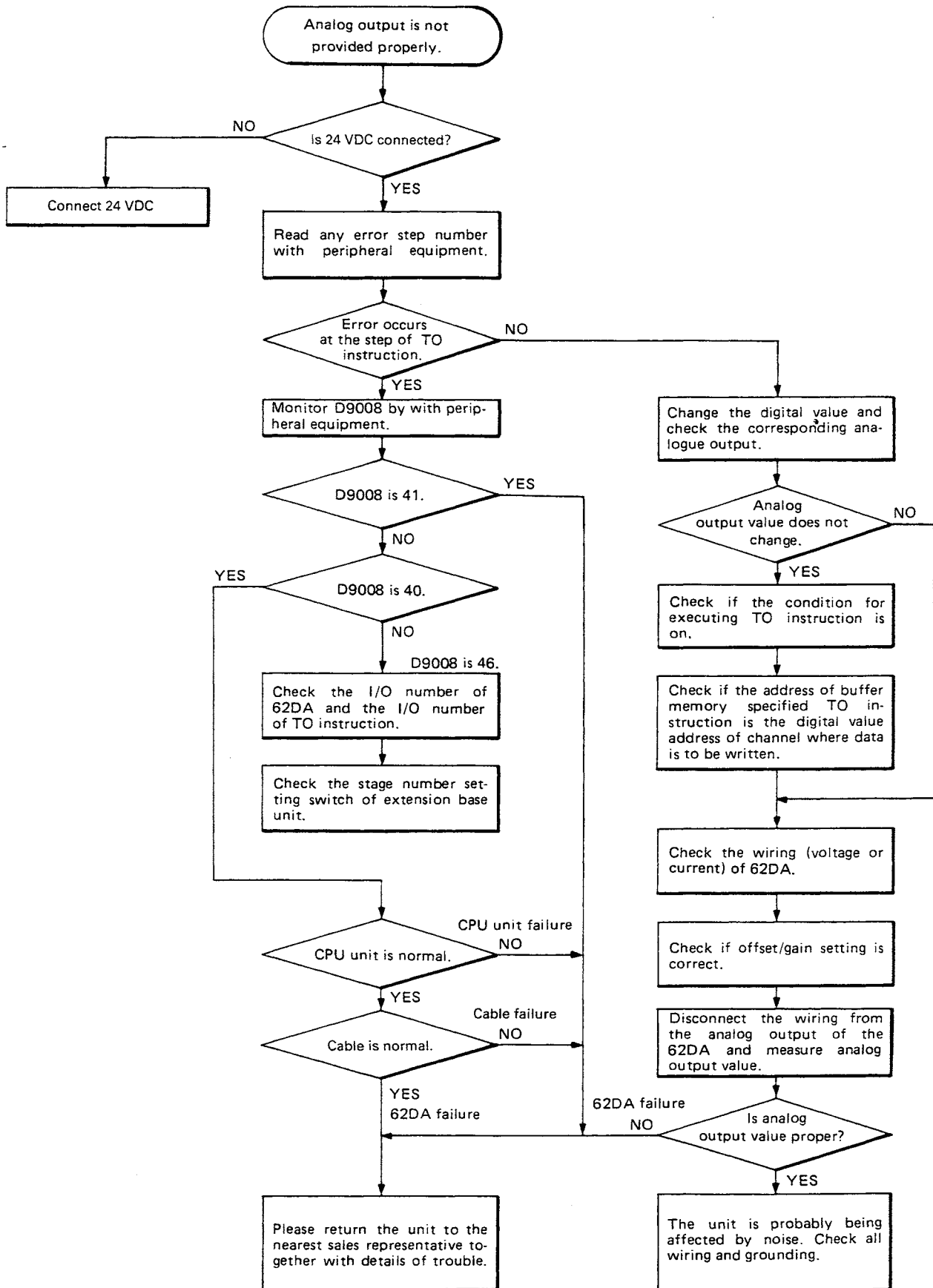

REMARK

The following contents are written into D9008 when an error has occurred during execution of the FROM or TO instruction.

Contents (BIN value) of Special Register D9008	CPU Status	Error and Cause
40	Stop	FROM and TO instructions cannot be executed. Hardware failure of 62DA (special function unit), CPU unit, or base unit.
41	Stop	When the FROM or TO instruction has been executed, access has been made to the special function unit but no answer is returned. The accessed 62DA (special function unit) has failed.
46	Stop	Access has been made (FROM or TO instruction has been executed) to a slot where the 62DA (special function unit) is not loaded. The content of FROM or TO instruction is incorrect or the stage number setting of extension base unit is improper.

APPENDIX

1. EXTERNAL DIMENSIONS

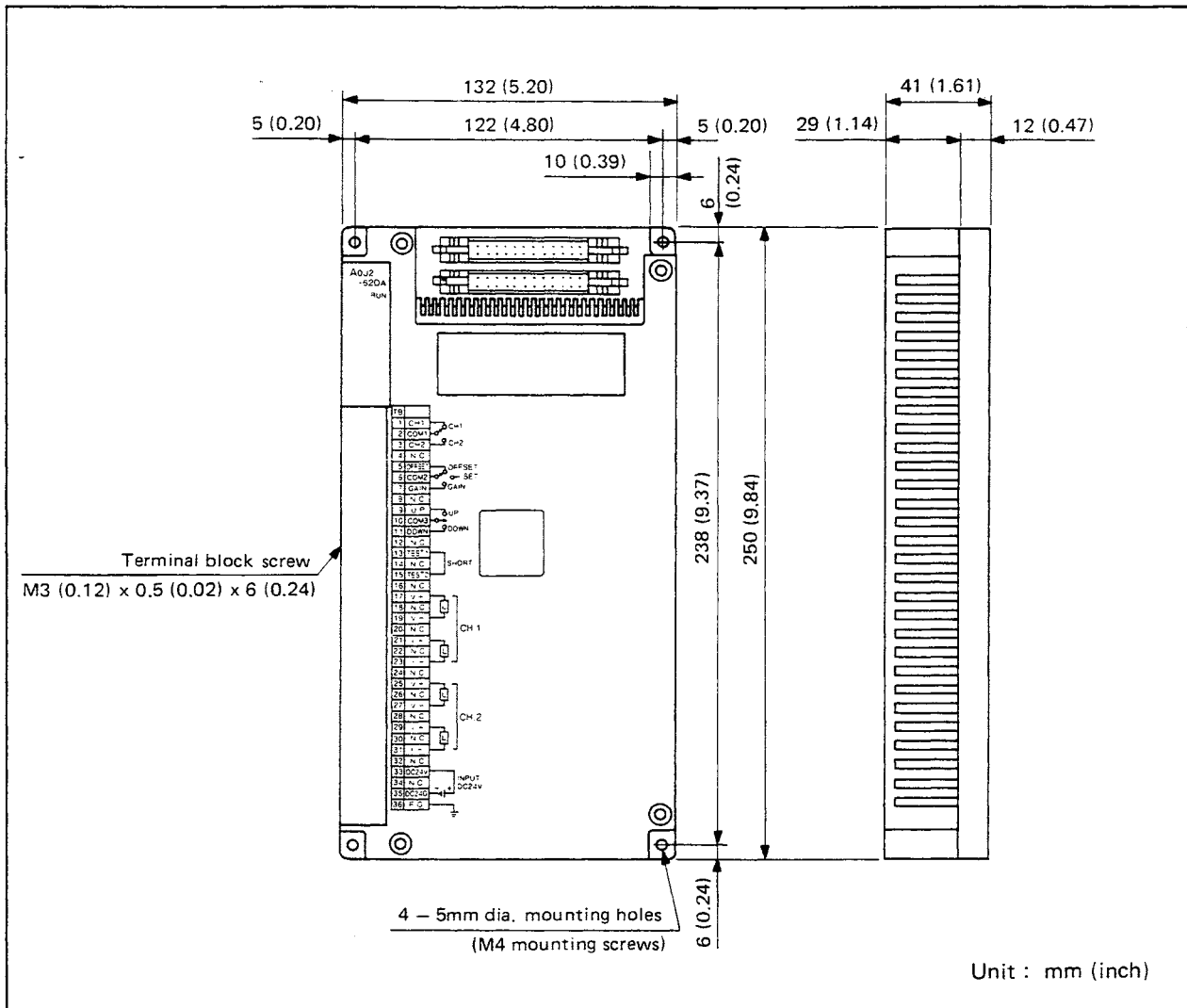

WARRANTY

Please confirm the following product warranty details before using this product.

1. Gratis Warranty Term and Gratis Warranty Range

If any faults or defects (hereinafter "Failure") found to be the responsibility of Mitsubishi occurs during use of the product within the gratis warranty term, the product shall be repaired at no cost via the sales representative or Mitsubishi Service Company.

However, if repairs are required onsite at domestic or overseas location, expenses to send an engineer will be solely at the customer's discretion. Mitsubishi shall not be held responsible for any re-commissioning, maintenance, or testing on-site that involves replacement of the failed module.

[Gratis Warranty Term]

The gratis warranty term of the product shall be for one year after the date of purchase or delivery to a designated place.

Note that after manufacture and shipment from Mitsubishi, the maximum distribution period shall be six (6) months, and the longest gratis warranty term after manufacturing shall be eighteen (18) months. The gratis warranty term of repair parts shall not exceed the gratis warranty term before repairs.

[Gratis Warranty Range]

- (1) The range shall be limited to normal use within the usage state, usage methods and usage environment, etc., which follow the conditions and precautions, etc., given in the instruction manual, user's manual and caution labels on the product.
- (2) Even within the gratis warranty term, repairs shall be charged for in the following cases.
 1. Failure occurring from inappropriate storage or handling, carelessness or negligence by the user. Failure caused by the user's hardware or software design.
 2. Failure caused by unapproved modifications, etc., to the product by the user.
 3. When the Mitsubishi product is assembled into a user's device, Failure that could have been avoided if functions or structures, judged as necessary in the legal safety measures the user's device is subject to or as necessary by industry standards, had been provided.
 4. Failure that could have been avoided if consumable parts (battery, backlight, fuse, etc.) designated in the instruction manual had been correctly serviced or replaced.
 5. Failure caused by external irresistible forces such as fires or abnormal voltages, and Failure caused by force majeure such as earthquakes, lightning, wind and water damage.
 6. Failure caused by reasons unpredictable by scientific technology standards at time of shipment from Mitsubishi.
 7. Any other failure found not to be the responsibility of Mitsubishi or that admitted not to be so by the user.

2. Onerous repair term after discontinuation of production

(1) Mitsubishi shall accept onerous product repairs for seven (7) years after production of the product is discontinued.

Discontinuation of production shall be notified with Mitsubishi Technical Bulletins, etc.

(2) Product supply (including repair parts) is not available after production is discontinued.

3. Overseas service

Overseas, repairs shall be accepted by Mitsubishi's local overseas FA Center. Note that the repair conditions at each FA Center may differ.

4. Exclusion of loss in opportunity and secondary loss from warranty liability

Regardless of the gratis warranty term, Mitsubishi shall not be liable for compensation of damages caused by any cause found not to be the responsibility of Mitsubishi, loss in opportunity, lost profits incurred to the user by Failures of Mitsubishi products, special damages and secondary damages whether foreseeable or not, compensation for accidents, and compensation for damages to products other than Mitsubishi products, replacement by the user, maintenance of on-site equipment, start-up test run and other tasks.

5. Changes in product specifications

The specifications given in the catalogs, manuals or technical documents are subject to change without prior notice.

6. Product application

- (1) In using the Mitsubishi MELSEC programmable logic controller, the usage conditions shall be that the application will not lead to a major accident even if any problem or fault should occur in the programmable logic controller device, and that backup and fail-safe functions are systematically provided outside of the device for any problem or fault.
- (2) The Mitsubishi programmable logic controller has been designed and manufactured for applications in general industries, etc. Thus, applications in which the public could be affected such as in nuclear power plants and other power plants operated by respective power companies, and applications in which a special quality assurance system is required, such as for Railway companies or Public service purposes shall be excluded from the programmable logic controller applications.

In addition, applications in which human life or property that could be greatly affected, such as in aircraft, medical applications, incineration and fuel devices, manned transportation, equipment for recreation and amusement, and safety devices, shall also be excluded from the programmable logic controller range of applications.

However, in certain cases, some applications may be possible, providing the user consults their local Mitsubishi representative outlining the special requirements of the project, and providing that all parties concerned agree to the special circumstances, solely at the users discretion.

D/A Converter Unit for A0J2 Type A0J2-62DA

User's Manual

MODEL	A0J2-62DA-USERS-E
MODEL CODE	13J612
IB(NA)-66093-F(0603)MEE	

 **MITSUBISHI ELECTRIC CORPORATION**

HEAD OFFICE : TOKYO BUILDING, 2-7-3 MARUNOUCHI, CHIYODA-KU, TOKYO 100-8310, JAPAN
NAGOYA WORKS : 1-14, YADA-MINAMI 5-CHOME, HIGASHI-KU, NAGOYA, JAPAN

When exported from Japan, this manual does not require application to the Ministry of Economy, Trade and Industry for service transaction permission.

Specifications subject to change without notice.